



Nortel Communication Server 1000

# IP Phone 1140E

## User Guide





# Revision history

## March 2009

Standard 02.06. This document is up-issued to note the change in CAT5E cable.

## January 2009

Standard 02.05. This document is up-issued to support Nortel Communications Server 1000 Release 5.5 for UNiStim 3.0. This document reflects changes in section Enabling USB Headset.

## December 2008

Standard 02.04. This document is up-issued to support Nortel Communications Server 1000 Release 5.5 for UNiStim 3.0. This document reflects changes in sections Setting up a conference call and Charging a call or charging a forced call.

## April 2008

Standard 02.03. This document is up-issued to support Nortel Communications Server 1000 Release 5.5 for UNiStim 3.0.

## May 2007

Standard 01.01. This document is up-issued to support CS 1000 Release 5.0. This document reflects the new document number.

## November 2006

Standard 5.00. This document is up-issued to reflect an update to Regulatory information.

## June 2006

Standard 4.00. This document is issued to support Nortel Communication Server 1000 Release 4.5 software. Added support for new security features.

### **February 2006**

Standard 3.00. This document is issued to support Nortel Communication Server 1000 Release 4.5 software.

### **January 2006**

Standard 2.00. This document is issued to support Nortel Communication Server 1000 Release 4.5 software.

### **November 2005**

Standard 1.00. This document is issued to support Nortel Communication Server 1000 Release 4.5 software.

# Contents

<b>About the Nortel IP Phone 1140E</b> .....	<b>11</b>
Basic features .....	11
Telephone controls .....	14
Telephone display .....	20
Call features and Flexible Feature Codes .....	20
Security features .....	21
Using encrypted calling .....	21
Managing your Station Control Password (SCPW) .....	21
<b>Entering and editing text</b> .....	<b>24</b>
Entering text using the IP phone dialpad .....	24
Entering text using the USB keyboard .....	25
Editing text using the soft keys .....	25
<b>Connecting the components</b> .....	<b>27</b>
Before you begin .....	28
Connecting the components of the phone .....	28
<b>Configuring Telephone Options</b> .....	<b>34</b>
Using the Telephone Options menu .....	35
Adjusting the volume .....	36
Adjusting the display screen contrast .....	37
Selecting a language .....	38
Selecting date and time format .....	39
Accessing display diagnostics .....	40
Choosing a local dialpad tone .....	40
Viewing IP Phone information .....	41
Diagnostics .....	42
Configuring call log options .....	43
Choosing a ring type .....	47

Enabling or disabling Call Timer .....	48
Enabling OnHook Default Path .....	49
Changing feature key labels .....	49
Configuring the name display format .....	51
Configuring Live Dialpad .....	52
<b>Configuring Local Menu options .....</b>	<b>54</b>
Using the 1. Preferences submenu .....	56
Changing 1. Display Settings .....	56
Changing 2. Language .....	57
Configuring 3. Headsets .....	58
Configuring 4. Bluetooth .....	65
Using the 2. Local Diagnostics submenu .....	77
Using 1. IP Set&DHCP Information .....	77
Using 2. Network Diagnostic Tools .....	77
Using 3. Ethernet Statistics .....	77
Using 4. IP Network Statistics .....	77
Using 5. USB Devices .....	78
Using the 3. Network Configuration menu .....	78
Using the 4. Lock Menu .....	78
<b>Making a call .....</b>	<b>79</b>
Using Off-hook dialing .....	79
Using On-hook dialing .....	80
Using handsfree dialing .....	81
Using the Directory applications .....	83
Making a call using the Corporate Directory .....	83
Making a call using the Personal Directory .....	84
Making a call using the Callers List .....	85
Making a call using the Redial List .....	86
Using Predial .....	86
Using AutoDial .....	87

Using Ring Again .....	89
Using Last Number Redial .....	90
Using Speed Call .....	90
Using System Speed Call .....	92
Using HotLine .....	92
Using intercom calling .....	92
<b>Answering a call .....</b>	<b>94</b>
<b>While on an active call .....</b>	<b>95</b>
Placing a call on hold .....	95
Transferring a call .....	96
Using Timed Reminder Recall .....	97
Using Attendant Recall .....	98
Using Call Park .....	98
Recording a Calling Party Number .....	101
Displaying incoming calls .....	101
Tracing a malicious call .....	102
<b>Incoming calls .....</b>	<b>103</b>
Using Automatic Answerback .....	103
Using Call Pickup .....	103
Using Call Waiting .....	105
<b>While away from your desk .....</b>	<b>107</b>
Using Call Forward .....	107
Using Internal Call Forward .....	108
Using Remote Call Forward .....	109
Securing your IP Phone .....	111

<b>Talking with more than one person</b> .....	<b>113</b>
Using the Call Join feature .....	113
Setting up a conference call .....	113
Using Conferee Selectable Display .....	115
Using Group Call .....	116
<b>Working without interruption</b> .....	<b>119</b>
Using Make Set Busy .....	119
<b>Additional call features</b> .....	<b>120</b>
Using AutoDial Transfer .....	120
Using the Buzz signal .....	121
Using Call Page Connect to make an announcement .....	121
Using Centrex/Exchange Line Switchhook Flash .....	122
Charging a call or charging a forced call .....	123
Using Enhanced Override .....	126
Using Forced Camp-on feature .....	127
Overriding a busy signal .....	128
Using Privacy Release .....	129
Using Radio Page .....	129
Using Voice Call .....	131
<b>Additional phone features</b> .....	<b>133</b>
Using the Personal Directory .....	133
Using the Callers List .....	136
Using the Redial List .....	138
Using Virtual Office .....	140
Logging in to Virtual Office .....	141
Using Virtual Office on your Remote IP Phone .....	142
Using Virtual Office on your Office IP Phone .....	144
Logging out of Virtual Office .....	146



Troubleshooting Virtual Office .....	147
Using Media Gateway 1000B .....	149
Using Test Local Mode .....	150
Using Resume Normal Mode .....	150
Troubleshooting MG 1000B .....	151
<b>Using Hospitality features .....</b>	<b>152</b>
Configuring Automatic Wake-Up .....	152
Activating Message Registration .....	154
Using Maid Identification .....	155
Displaying Room Status .....	156
<b>Accessing External Server Applications .....</b>	<b>159</b>
<b>Flexible Feature Codes (FFCs) .....</b>	<b>160</b>
<b>Regulatory and safety information .....</b>	<b>161</b>
Other .....	163
DenAn regulatory notice for Japan .....	164
<b>Terms you should know .....</b>	<b>165</b>
<b>Index .....</b>	<b>169</b>



# About the Nortel IP Phone 1140E

Your Nortel IP Phone 1140E brings voice and data to the desktop by connecting directly to a Local Area Network (LAN) through an Ethernet connection.

In this guide, self-labeled line/programmable feature key labels appear beside the keys, and context-sensitive soft key labels appear directly above the keys. Figure 1 shows self-labeled line/programmable feature keys and context-sensitive soft keys.

**Figure 1: Self-labeled line/programmable feature keys and context-sensitive soft keys**

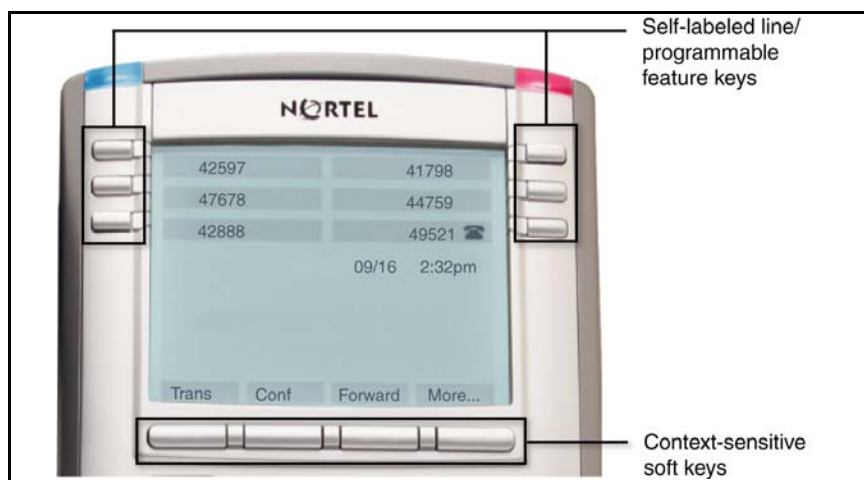

## Basic features

Your IP Phone 1140E supports the following features:

- six self-labeled line/programmable feature keys with labels and indicators
- four context-sensitive soft keys

For information about context-sensitive soft keys, see *New in This Release Communication Server Release 5.0* (NN43001-115).

**Note:** Some IP Phone 1140E phones are not configured to support soft key functionality. Consult your system administrator.

- graphical, high-resolution LCD display, backlit, with adjustable contrast
- high-quality speaker phone
- volume control keys for adjusting ringer, speaker, handset, and headset volume
- six specialized feature keys:
  - Quit
  - Directory
  - Message/Inbox
  - Shift/Outbox
  - Services
  - Copy
- six call-processing fixed keys:
  - Mute
  - Handsfree
  - Goodbye
  - Expand
  - Headset
  - Hold
- gigabit Ethernet ports
- built-in gigabit Ethernet switch for shared PC access
- headset jack with an On/Off key
- USB port to support a keyboard, mouse, or wireless headset. Powered downstream 1.1-compliant USB hubs are supported, including USB 2.0 hubs, if they offer USB 1.1 backwards compliancy.
- automatic network configuration
- Graphical XAS
- hearing aid compatibility

- wireless headset support using a Bluetooth® 1.2 wireless technology compliant Audio Gateway (Headset Profile, Bluetooth Power Class 2).
- Accessory Expansion Module port to connect the Expansion Module for IP Phone 1100 Series (Expansion Module)



For information about using the Expansion Module, see the *Expansion Module for IP Phone 1100 Series User Guide* (NN43130-101).

Figure 2 shows the IP Phone 1140E.

**Figure 2: IP Phone 1140E**



## Telephone controls

This section describes the controls on your IP Phone 1140E. In some geographic regions, the IP Phone 1140E is offered with key caps that have English text labels. In this document, text in parentheses indicates the labels that appear on the key caps, for example, (Services).



**Context-sensitive soft keys** are located below the display area. The LCD label above each key changes based on the active feature.



When a triangle appears before a soft key label, the feature is active.

Press the **More** key to access the next layer of context-sensitive soft keys (self-labeled).



The keys on either side of the LCD display area are **self-labeled line/programmable feature keys**, with labels on the LCD. These keys also function as **line (DN)** keys.



A steady LCD light beside a line (DN) key indicates that the line is active. A flashing LCD light indicates the line is on hold or the feature is being programmed.



A steady LCD light beside a feature key indicates that the feature is active. A flashing LCD light indicates that the feature is being programmed.

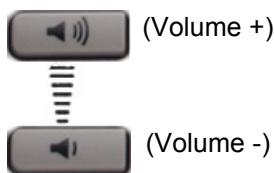

Use the **Volume control** buttons to adjust the volume of the ringer, handset, headset, speaker, and the Handsfree feature. Press the top button to increase the volume, and press the bottom button to decrease the volume.



(Mute)

Press the **Mute** key to listen to the receiving party without transmitting. Press the **Mute** key again to return to two-way conversation. The **Mute** key applies to handsfree, handset, and headset microphones.

The Mute LED indicator, located on the **Mute** key, flashes to indicate that the microphone is muted.



(Handsfree)

Press the **Handsfree** key to activate handsfree.

The Handsfree LED indicator, located on the **Handsfree** key, lights to indicate when handsfree is active.



Use the **Navigation** keys to scroll through menus and lists appearing on the LCD display screen. The outer part of this key cluster rocks for up, down, left, and right movements.

Use **Up** and **Down** to scroll up and down in lists, and the **Left** and **Right** keys to position the cursor. In some dialog boxes that appear on your phone, you can also use the **Left** and **Right** keys to select editable fields; press the **Right** key to select the field below the current selection, or the **Left** key to select the one above.



Use the **Enter** key, at the center of the Navigation key cluster, to confirm menu selections.

In most menus, you can use the **Enter** key instead of the **Select** soft key.



(Hold)

Press the **Hold** key to put an active call on hold. Tap the flashing line (DN) soft key to return to the caller on hold.



(Expand)

Use the **Expand** key to access external server applications



(Headset)

Press the **Headset** key to answer a call using the headset or to switch a call from the handset or handsfree to the headset.

The Headset LED indicator, located on the **Headset** key, lights to indicate that the headset is in use.



(Headset)

Press the **Headset** key twice to open the Bluetooth Setup menu.



(Headset)

If Bluetooth wireless technology is not enabled on your phone, this menu is not available.



(Goodbye)

Use the **Goodbye** key to terminate an active call.





When a message is waiting, the red **Visual Alerter/Message Waiting indicator** lights. Also, when the ringer sounds, this indicator flashes.



When your IP Phone 1140E firmware is being updated, the blue **Feature Status Lamp** indicator flashes.

To find out if additional features are supported for this lamp, contact your administrator.



(Copy)

Press the **Copy** Key to copy entries to your Personal Directory from other lists, such as the Caller List, Redial List, and Corporate Directory.



(Quit)

Press the **Quit/Stop** key to exit an active menu or dialog. Pressing the **Quit/Stop** key does not affect the status of active calls.

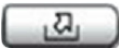

(Shift/Outbox)

Press the **Shift/Outbox** key to toggle between two feature key pages and to access an additional six lines/features.

This function is not available on all phones; consult your system administrator.



(Msg/Inbox)

Press the **Message/Inbox** key to access your voice mailbox.

This function is not available on all phones; consult your system administrator.



(Directory)

Press the **Directory** key to access directory services.



(Services)

Press the **Services** key and use the navigation keys to access the following items:

- Telephone Options:
  - Volume adjustment
  - Contrast adjustment
  - Language
  - Date/Time
  - Display diagnostics
  - Local Dialpad Tone
  - Set Info
  - Diagnostics
  - Call Log Options
  - Ring type
  - Call Timer
  - On hook default path
  - Change Feature Key Label
  - Name Display Format
  - Live Dialpad



(Services)  
(continued)

- Password Admin:
  - Station Control PasswordThe **Password Admin** menu is not available on all IP Phone 1140E phones. Consult your system administrator.
- Display Network Diagnostics Utilities  
Only your system administrator or service provider can use Display Network Diagnostics Utilities to perform Internet diagnostics.
- Virtual Office Login and Virtual Office Logout (if Virtual Office is configured)
- Test Local Mode and Resume Local Mode (if Media Gateway 1000B is configured)

Press the **Services** key to exit from any menu or menu item.



(Services)



(Services)

Press the **Services** key twice to access the Local Tools menu, and use the navigation keys to access the following items:

1. Preferences
2. Local Diagnostics
3. Network Configuration
4. Lock Menu

If you attempt to access the Local Tools menu and a dialog box appears prompting you for a password, contact your system administrator. Your system administrator can establish a password for the Local Tools menu.

## Telephone display

Your IP Phone 1140E has three display areas:

- The upper display area provides labels for the six self-labeled line/programmable feature key labels.
- The middle display area contains single-line information for items such as caller number, caller name, Call Timer, feature prompt strings, user-entered digits, date and time information, and IP Phone information.
- The lower display area provides labels for the four context-sensitive soft keys.

Figure 3 shows an idle LCD screen.

**Figure 3: IP Phone 1140E LCD screen**

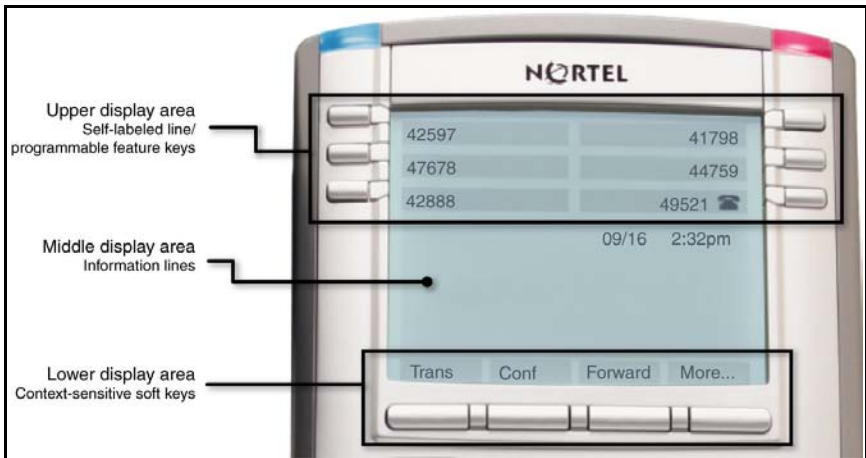

## Call features and Flexible Feature Codes

Some features are not available on all IP Phones. Call features and Flexible Feature Codes (FFC) must be assigned to your IP Phone and supported by system software. Contact your system administrator to configure these features and codes on your IP Phone.

## Security features

The following security features are available on your IP Phone 1140E:

- Using encrypted calling
- Managing your Station Control Password (SCPW)

### Using encrypted calling

Your IP Phone 1140E supports secure communication using SRTP media encryption. If the feature is enabled, a security icon (🔒) appears on the screen when your call is secured using SRTP media encryption. Contact your system administrator to find out if this feature is available for your use.

### Managing your Station Control Password (SCPW)

Your Station Control Password (SCPW) enables the following security features:

- Electronic Lock to prevent others from making calls from your IP Phone
- password-protected IP Phone features (for example, Personal Directory, Redial List, and Callers List)

Your system administrator defines your initial SCPW. Contact your system administrator for detailed information.

#### To change your SCPW:



(Services)

1. Press the **Services** key.



2. Press the **Up/Down** keys to scroll and highlight **Password Admin**.



3. Press the **Enter** key.



4. Use the dialpad to enter your password at the prompt.



5. Press the **Up/Down** keys to scroll and highlight **New Password**.



6. Press the **Enter** key.



7. Use the dialpad to enter the new password.

Select



8. Press the **Select** soft key to accept the new password.

If you are locked out of your IP Phone 1140E, or if you forget your SCPW, contact your system administrator.

**Note:** The default configuration for Password Protection is off.

**To turn Password Protection on or off:**



(Directory)

1. Press the **Directory** key.



2. Press the **Up/Down** navigation keys to scroll and highlight **Change Protection Mode**.



3. Use the dialpad to enter your password (if Password Protection is enabled).

Enter



4. Press the **Enter** soft key.



5. Press the **Up/Down** navigation keys to scroll and highlight one of the following:

- **Enable Password Protection**
- **Disable Password Protection**

6. Choose one of the following soft keys:

- **Yes** to accept the selection
- **No** to return to the Directory menu

Yes

No

or



Done



7. Press the **Done** soft key.

# Entering and editing text

You can enter and edit text on your IP Phone 1140E using the following methods:

- “Entering text using the IP phone dialpad” on page 24
- “Entering text using the USB keyboard” on page 25
- “Editing text using the soft keys” on page 25

The use of any of these methods for text entry or editing depends on the application. Table 1 shows the applications and input devices that you can use for text entry.

**Table 1: Application text entry**

For:	Use:
Call Server-related applications (for example, changing feature key labels, adding personal directory entries, or dialing)	Dialpad USB keyboard for numeric entries only
Graphical applications	USB keyboard
Local Tools menu	USB keyboard Dialpad for numeric entries

## Entering text using the IP phone dialpad

You can use the dialpad to enter text when you use features such as Personal Directory, Redial List, and Callers List. Use the dialpad in conjunction with the soft keys.

For example, if you want to enter the letter A, press the number **2** key once. If you want to enter the letter C, press the number **2** key three times. No letters are associated with the number 1 or the 0 keys.



## Entering text using the USB keyboard

You can use the USB keyboard, when connected, to enter text in the tools and graphical applications.

For number entry in phone applications (for example, when dialing), you can use the keyboard to enter digits (0–9), as well as \* and #. Other characters are ignored.

When on a call, you can use the function keys (f1, f2, f3, f4, f5, f6, f7, and f8) to control the IP Phone. Table 2 shows the function keys and their associated action during IP Phone calls.

**Table 2: USB keyboard function keys during IP Phone calls**

Function key	Action
f1	Go to Handsfree mode
f2	Go to Headset mode
f3	Place the current call on hold
f4	Mute the current call
f5	Volume up
f6	Volume down
f7	Copy
f8	Quit

## Editing text using the soft keys

You can use soft keys to edit text when you use features such as Personal Directory, Redial List, and Callers List. Use the soft keys in conjunction with the dialpad.

To edit an entry in your Personal Directory, press the **Directory** key, and select the desired entry from your Personal Directory.

### To edit text with the soft keys:

1. Press the **Edit** soft key.
2. Press the **Left/Right** navigation keys to move through the text.
3. Select the appropriate editing soft key for the operation you want to perform.
4. If the character you want is not visible, press the **More** soft key to access the next layer of soft keys.
5. To add non-alphanumeric symbols, press the **Symbol** soft key, and perform the following:
  - a. Press the **Up** navigation key to access the symbols.
  - b. Press the **Left/Right** navigation keys to move to a specific symbol.
  - c. Press the **Choose** soft key to select a symbol.
6. Press the **Next** soft key to submit your changes.

When you are editing text using the soft keys, various commands are available on the soft keys to help you, as described in Table 3.

**Table 3: Editing soft key description**

Soft key	Description
Cancel	Cancel an action.
Choose	Select a non-alphanumeric symbol (available only after the <b>Symbol</b> soft key is selected).
Clear	Clear the input field.
Case	Switch the next character to either uppercase or lowercase.
Delete	Backspace one character.
Done/Select/Enter	Varies, depending on the state of your phone.
More	Access additional soft keys.

# Connecting the components

Figure 4 shows connections on the IP Phone 1140E.

**Figure 4: IP Phone 1140E connections**

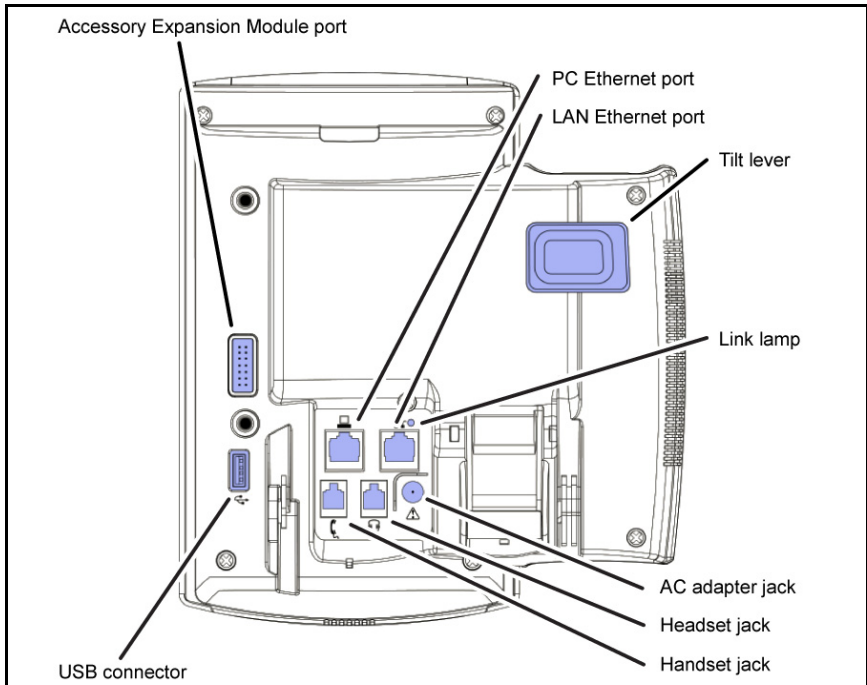

## WARNING

Ensure that the protective rubber cap on the Accessory Expansion Module port is in place when the port is not in use. Connecting anything other than the proper Expansion Module for IP Phone 1100 Series connector to this port can cause damage to the IP Phone.

## Before you begin

---



**CAUTION**

**Damage to Equipment**

Do not plug your IP Phone 1140E into a regular phone jack. This results in severe damage to the IP Phone. Consult your system administrator to ensure that you plug your IP Phone into a 10/100BaseT Ethernet jack.



**CAUTION**

Your IP Phone 1140E is designed for use in an indoor environment only.

## Connecting the components of the phone

---



**WARNING**

Your IP Phone 1140E is shipped with the base locked in position. To avoid damaging your phone, press the wall-mount lever, located just under the Handsfree key as indicated in Figure 5 on page 29, to release the base and pull it away from the phone.

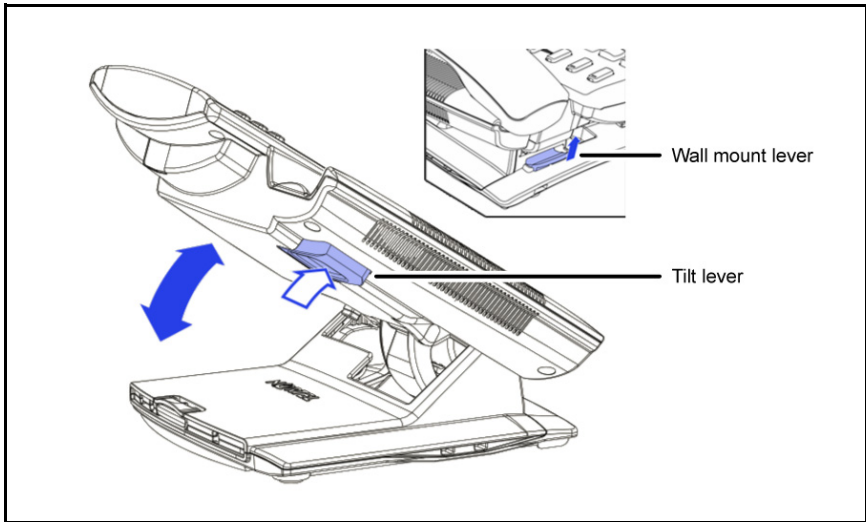
**Figure 5: Release the IP Phone 1140E from the stand**

Use the following steps to connect the components of your phone.

1. Remove the stand cover. Pull upward on the center catch as indicated in Figure 6 on page 30, and remove the stand cover. The cable routing tracks are now accessible.

Figure 6: Remove the stand cover

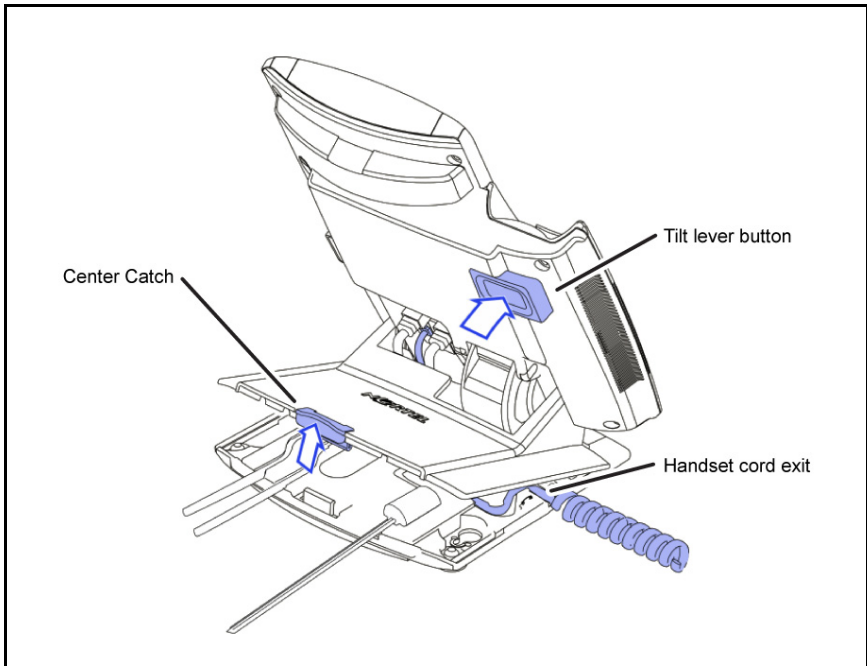

2. Connect the AC power adapter (optional). Connect the adapter to the AC adapter jack in the bottom of the phone. Form a small bend in the cable, and then thread the adapter cord through the channels in the stand.











**WARNING**

Use your IP Phone 1140E with the approved Nortel AC Adapter (model #N0089601).

**Note 1:** Your IP Phone 1140E supports both AC power and Power over Ethernet options, including IEEE 802.3af standard power. To use local AC power, the optional AC adapter can be ordered separately. To use Power over Ethernet, where power is delivered over the CAT-

5e cable, the LAN must support Power over Ethernet, and an AC adapter is not required.

**Note 2:** You must use CAT-5e (or later) cables if you want to use gigabit Ethernet.

3. Install the handset. Connect the end of the handset cable with the short straight section into the handset. Connect the end of the handset cable with the long straight section to the back of the phone, using the RJ-9 handset jack marked with the symbol . Form a small bend in the cable, and then thread the handset cord through the channels in the stand so that it exits behind the handset on the right side, in the Handset cord exit in the stand base marked with the symbol , as shown in Figure 7 on page 32.
4. Install the headset (optional). If you are installing a headset, plug the connector into the RJ-9 headset jack marked with the symbol  on the back of the phone, and thread the headset cord along with the handset cord through the channels in the stand, so that the headset cord exits the channel marked with the symbol .
5. Install the Ethernet cable. Connect one end of the supplied Ethernet cable to the back of your phone using the RJ-45 connector marked with the symbol , and thread the network cable through the channel marked with the symbol .
6. If you are connecting your PC through the phone, you will require a second CAT-5e cable. Only one cable is included with the IP Phone 1140E package. Install the Ethernet cable connecting the PC to the phone (optional). Connect one end of the PC Ethernet cable to your phone using the RJ-45 connector marked with the symbol  and thread it through the channel marked with the symbol . Connect the other end to the LAN connector on the back of your PC.
7. Install additional cables. If applicable, plug in optional USB devices. Connect the Ethernet cable to the LAN Ethernet connection. If you are using an AC power adapter, plug the adapter into an AC outlet.

### Figure 7: Cable routing tracks and mounting holes

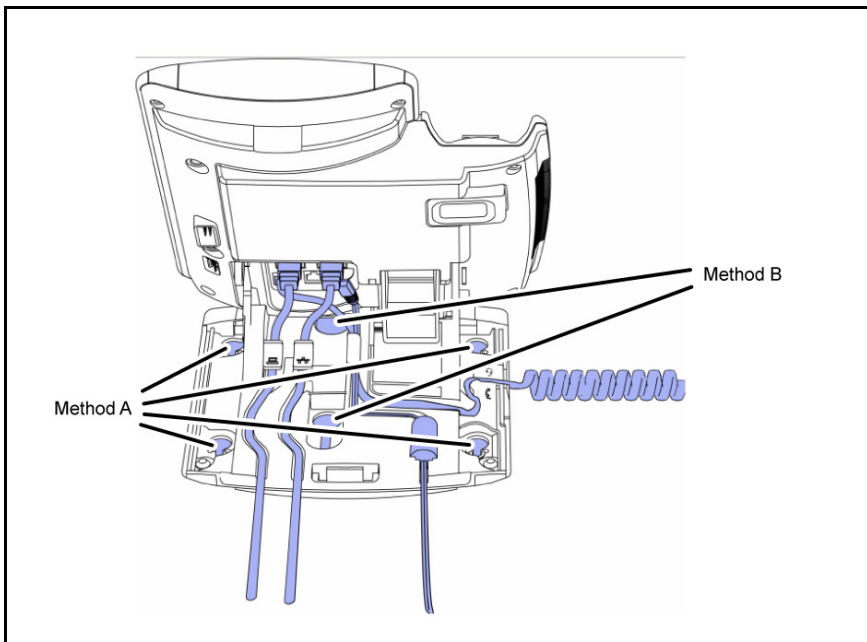

8. Wall-mount your phone (optional). Your IP Phone 1140E can be mounted either by: (Method A) using the mounting holes on the bottom of the phone stand, or (Method B) using a traditional-style wall-mount box with RJ-45 connector and 15-cm (6-inch) RJ-45 cord (not provided).

*Complete steps 1-7, as needed, before you wall-mount your phone:*

**Method A:** Press the wall-mount lever, and pull the phone away from the stand, as shown in Figure 5 on page 29. Using the stand cover (the part you removed in step 1), mark the wall-mount holes by pressing the bottom of the stand cover firmly against the wall in the location where you wish to install the phone. Four small pins on the bottom of the stand cover make marks on the wall. Use the marks as a guideline for installing the wall-mount screws (not provided). Install the screws so that they protrude 3 mm (1/8 inch) from the wall, and then install the phone stand mounting holes over the screw heads. You may need to remove the phone from the wall to adjust the lower screws. When the lower screws are snug, install the phone on the



mounting screws, and then tighten the top screws. See Figure 7 on page 32.

**Method B:** Attach the 15-cm (6-inch) CAT5e cable, position the stand over the mounting rivets, and slide the phone down the wall so that the rivets fit into the slots on the stand, indicated in Figure 7 on page 32 (Method B).

9. Replace the stand cover. Ensure that all cables are neatly routed and press the stand cover into place until you hear a click
10. Put the phone in the wall-mount position (optional). If you wall-mounted your phone, put it in the wall-mount position by holding the Tilt Lever and pressing the phone towards the base until the phone is parallel with the base. Release the Tilt Lever and continue to push the phone towards the base until you hear an audible click. Ensure the phone is securely locked in position.

# Configuring Telephone Options

Your IP Phone 1140E **Services** menu lists the following submenus:

- The **Telephone Options** menu enables you or your system administrator to configure IP Phone preferences. The **Telephone Options** menu offers the options shown in Figure 8.
- The **Password Admin** menu enables you or your system administrator to change the Station Control Password (SCPW).
- The **Virtual Office Login** and **Test Local Mode** (for branch office) menus are listed when an IP Phone 1140E Class of Service is configured for Virtual Office and branch office. (For more information, see “Using Virtual Office” on page 140).

**Note:** The **Password Admin**, **Virtual Office Login**, and **Test Local Mode** menus are not available on all IP Phone 1140E phones. Consult your system administrator.

**Figure 8: Telephone Options menu**

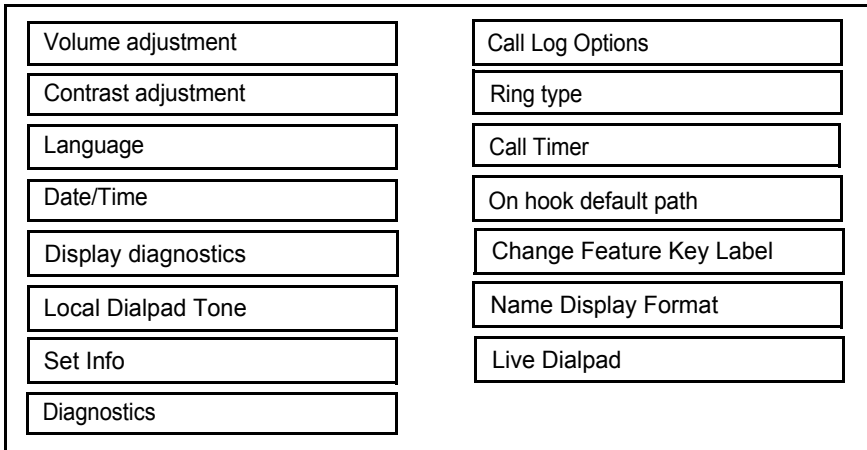

**Note:** When an option has a sublist, an ellipsis (...) appears after the option.

## Using the Telephone Options menu

---

Use the **Telephone Options** menu to access the following:

- “Adjusting the volume” on page 36
- “Adjusting the display screen contrast” on page 37
- “Selecting a language” on page 38
- “Selecting date and time format” on page 39
- “Accessing display diagnostics” on page 40
- “Choosing a local dialpad tone” on page 40
- “Viewing IP Phone information” on page 41
- “Diagnostics” on page 42
- “Configuring call log options” on page 43
- “Choosing a ring type” on page 47
- “Enabling or disabling Call Timer” on page 48
- “Enabling OnHook Default Path” on page 49
- “Changing feature key labels” on page 49
- “Configuring the name display format” on page 51
- “Configuring Live Dialpad” on page 52

**To use the Telephone Options menu:**



(Services)

1. Press the **Services** key.



2. Press the **Up/Down** navigation keys to scroll and highlight **Telephone Options**.



3. Press the **Enter** key.



4. Press the **Up/Down** navigation keys to scroll and highlight an option (for example, **Language...**).



5. Press the **Enter** key. The display provides information required to adjust your selection.

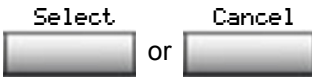

6. Choose one of the following:
  - Press the **Select** soft key to save changes and return to the **Telephone Options** menu.
  - Press the **Cancel** soft key to keep existing configurations.

## Adjusting the volume

To adjust the volume, press the **Services** key and select **Telephone Options**, and select **Volume adjustment...**

To adjust the volume:



1. Press the **Up/Down** navigation keys to scroll and highlight one of the following:
  - **Ringer**
  - **Handset listen**
  - **Handsfree listen**
  - **Headset listen**
  - **Buzzer**



2. Press the **Enter** key.

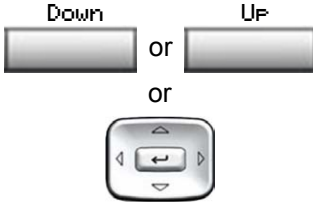

3. To increase or decrease the volume, do one of the following:
  - Press the **Down** and **Up** soft keys.
  - Press the **Up/Down** navigation keys.



4. Choose one of the following:
  - Press the **Select** soft key to save the volume level and return to the **Telephone Options** menu.
  - Press the **Cancel** soft key to keep existing configurations.

### Adjusting the display screen contrast

To adjust the LCD screen contrast, press the **Services** key, select **Telephone Options**, and select **Contrast adjustment**.

You can also adjust the contrast using the Local Tools menu; Nortel recommends that you use the control in the Telephone Options menu.

**Note:** If you have an Expansion Module for IP Phone 1100 Series attached to your IP Phone, adjusting the IP Phone LCD screen contrast also adjusts the display screen contrast configuration for the Expansion Module for IP Phone 1100 Series.

To adjust the display screen contrast:

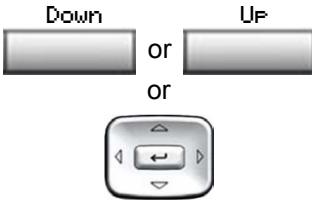

1. To increase or decrease the display contrast level, choose one of the following:
  - Press the **Down** and **Up** soft keys.
  - Press the **Up/Down** navigation keys.

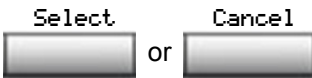

2. Choose one of the following:
  - Press the **Select** soft key to save the changes and return to the **Telephone Options** menu.
  - Press the **Cancel** soft key to keep existing configurations.

## Selecting a language

The display is available in multiple languages. To choose a language, press the **Services** key, select **Telephone Options**, and select **Language...**

This language setting controls the language used by features on your phone only. To set the language used elsewhere on your phone, press **Services** twice, select Preferences, and select Language.

To select a language:



1. Press the **Up/Down** navigation keys to scroll and highlight the desired language (for example, German [Deutsche]).

**Note:** Some languages may not be installed on your IP Phone. Contact your system administrator for more information about available languages.

2. Choose one of the following:

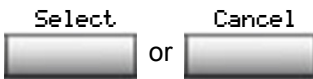

- Press the **Select** soft key to save the desired language and return to the **Telephone Options** menu.
- Press the **Cancel** soft key to keep existing configurations.

## Selecting date and time format

Several date and time formats are available. Formats are based on the 12-hour and 24-hour clocks. To select the date and time format, press the **Services** key, select **Telephone Options**, and select **Date/Time...**

To select a date and time format:



1. Press the **Up/Down** navigation keys to scroll and highlight the desired format. Sample formats appear on the upper-right side of the display area.

2. Choose one of the following:

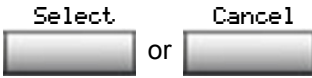

- Press the **Select** soft key to save the format and return to the **Telephone Options** menu.
- Press the **Cancel** soft key to keep existing configurations.

## Accessing display diagnostics

The Display diagnostics option tests the IP Phone display screen and indicator lights. To access Display diagnostics, press the **Services** key, select **Telephone Options**, and select **Display diagnostics**.

To use Display diagnostics:



1. Press the **Up/Down** navigation keys to scroll through the list to view display capabilities.

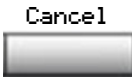

2. Press the **Cancel** soft key to return to the **Telephone Options** menu.

## Choosing a local dialpad tone

The Local DialPad Tone option produces Dual-Tone Multi-Frequency (DTMF) sounds, a single tone, or no sound when you press a key on the dialpad. To choose a local dialpad tone, press the **Services** key, select **Telephone Options**, and select **Local DialPad Tone**.



To choose a local dialpad tone:



1. Press the **Up/Down** navigation keys to scroll and highlight one of the following dialpad tones:
  - **None** to disable all tones
  - **Short Click** to enable a single tone for all keys
  - **DTMF** to turn on a separate DTMF tone for each key

2. Choose one of the following:



- Press the **Select** soft key to save the tone selection and return to the **Telephone Options** menu.
- Press the **Cancel** soft key to keep existing configurations.

## Viewing IP Phone information

The Set Info option displays the following phone-specific information:

- General Info
- Set IP Info
- Ethernet Info
- Server Info
- Encryption Info

To view IP Phone information, press the **Services** key, select **Telephone Options**, and select **Set Info**.

To view IP Phone information:



Cancel



1. Press the **Up/Down** navigation keys to scroll through the list to view IP Phone information.
2. Press the **Cancel** soft key to return to the **Telephone Options** menu.

## Diagnostics

The Diagnostics option displays the following phone-specific information:

- Diag Tools (Ping, do Route Traces)
- EtherStats (Speed, Auto Neg, CRC Errors, Collision)
- IP Stats (Packet Info)
- RUDP Stats (Message receive or transmit)
- QOS Stats

To view diagnostic information, press the **Services** key, select **Telephone Options**, and select **Diagnostics**.

To view diagnostic information:



Cancel



1. Press the **Up/Down** navigation keys to scroll through the list of diagnostic information.
2. Press the **Cancel** soft key to return to the **Telephone Options** menu.

## Configuring call log options

Use the call log option to configure the following preferences:

- “Configuring the Callers List log” on page 43
- “Configuring New Call Indication” on page 44
- “Configuring Preferred Name Match” on page 45
- “Configuring Area Code Setup” on page 45

### Configuring the Callers List log

You can configure the Callers List to log all incoming calls or only unanswered calls. The default configuration is Log all calls. To log only unanswered calls, press the **Services** key, select **Telephone Options**, and select **Call Log Option**.

To log only unanswered calls:



1. Press the **Up/Down** navigation keys to scroll and highlight the **Log Mode** option.



2. Press the **Enter** key.



3. Press the **Up/Down** navigation keys to scroll and highlight **Log unanswered calls**.

4. Choose one of the following:



- Press the **Select** soft key to save the configuration.
- Press the **Cancel** soft key to keep existing configurations.

### Configuring New Call Indication

You can configure your IP Phone 1140E to display a message to indicate that a new incoming call was received. The default configuration is On. To configure new call indication, press the **Services** key, select **Telephone Options**, and select **Call Log Option**.

To configure New Call Indication:



1. Press the **Up/Down** navigation keys to scroll and highlight the **Log Mode** option.



2. Press the **Enter** key.



3. Press the **Up/Down** navigation keys to scroll and highlight **New Call Indication**.



4. Press the **Enter** key.



5. Press the **Up/Down** navigation keys to scroll and highlight one of the following:
  - **New call indication off**
  - **New call indication on**

Select

Cancel

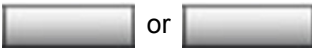

6. Choose one of the following:
  - Press the **Select** soft key to save the configuration.
  - Press the **Cancel** soft key to keep existing configurations.

## Configuring Preferred Name Match

You can configure your IP Phone 1140E to display the name of the caller as defined in your Personal Directory. The default configuration is Off. To configure Preferred Name Match, press the **Services** key, select **Telephone Options**, and select **Call Log Option**.

### To configure Preferred Name Match:



1. Press the **Up/Down** navigation keys to scroll and highlight **Preferred Name Match**.



2. Press the **Enter** key.



3. Press the **Up/Down** navigation keys to scroll and highlight one of the following:
  - **Preferred name match on**
  - **Preferred name match off**

4. Choose one of the following:



- Press the **Select** soft key to save the configuration.
- Press the **Cancel** soft key to keep existing configurations.

## Configuring Area Code Setup

Use the **Area Code Setup** menu to save up to three area codes. When an incoming call arrives with an area code that matches one of the three stored area codes, the incoming call number is reordered to display the phone number followed by the area code (as opposed to the area code followed by the phone number).

This reordering is also performed when you scroll through your Callers List. To configure area codes, press the **Services** key, select **Telephone Options**, and select **Call Log Option**.

**To configure default area codes (maximum of three):**



1. Press the **Up/Down** navigation keys to scroll and highlight **Area Code Setup**.



2. Press the **Enter** key.



3. Press the **Up/Down** navigation keys to scroll and highlight one of the following:

- Area Code # 1
- Area Code # 2
- Area Code # 3



4. Press the **Enter** key.



5. Use the dialpad to enter the number at the prompt.

Select

Cancel

or

6. Choose one of the following:
  - Press the **Select** soft key to save the configuration.
  - Press the **Cancel** soft key to keep the existing configurations.

To edit area code display:



1. Press the **Up/Down** navigation keys to scroll and highlight **Area Code Setup**.



2. Press the **Enter** key.



3. Press the **Up/Down** navigation keys to scroll and highlight one of the following:
  - Area Code # 1
  - Area Code # 2
  - Area Code # 3



4. Press the **Enter** key.



5. Use the dialpad to edit the number.



6. Choose one of the following:
  - Press the **Select** soft key to save the configuration.
  - Press the **Cancel** soft key to keep existing configurations.

## Choosing a ring type

The Ring type... option configures the IP Phone ring tone. To choose a ring type, press the **Services** key, select **Telephone Options**, and select **Ring type...**

To select a ring type:



Play



Select



Stop



Cancel



1. Press the **Up/Down** navigation keys to scroll and highlight one of the ring types.
2. Press the **Play** soft key to sample the ring tone.
3. Choose one of the following:
  - Press the **Select** soft key to save the ring type and return to the **Telephone Options** menu.
  - Press the **Stop** soft key and use the **Up/Down** navigation keys to select a different ring type.
  - Press the **Cancel** soft key to keep existing configurations.

## Enabling or disabling Call Timer

The call timer measures how long you are on each call. To enable Call Timer, press the **Services** key, select **Telephone Options**, and select **Call Timer**.

To enable or disable Call Timer:

On



or

Off



1. Choose one of the following:
  - To turn on the call timer, press the **On** soft key.
  - To turn off the call timer, press the **Off** soft key.



2. Choose one of the following:

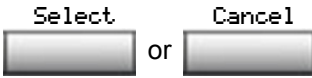

- Press the **Select** soft key to save the configuration and return to the **Telephone Options** menu.
- Press the **Cancel** soft key to keep existing configurations.

## Enabling OnHook Default Path

The OnHook Default Path option allows you to choose whether to use a headset or the Handsfree feature to operate your IP Phone while it is on-hook. To enable OnHook Default Path, press the **Services** key, select **Telephone Options**, and select **OnHook Default Path**.

To enable OnHook Default Path:



1. Press the **Up/Down** navigation keys to highlight one of the following:

- **Handsfree enable**
- **Headset enable**

2. Choose one of the following:



- Press the **Select** soft key to save the default path and return to the **Telephone Options** menu.
- Press the **Cancel** soft key to keep existing configurations.

## Changing feature key labels

The Change feature key label option renames the label displayed next to each feature key or restores the default labels to the keys (collectively or individually). To rename feature key labels, press the **Services** key, select **Telephone Options**, and select **Change feature key labels**.

**Note:** If a feature key is configured as an auto-dial key, the label does not change if the auto-dial key configuration changes.

### To rename the labels:



1. Press the **Enter** key.



2. Press the feature key that you are changing.

If you press a prime DN key, an error message appears.



3. Enter the new information for the feature key label. To enter special characters, press the **Up** navigation key. For information about entering text, refer to “Entering text using the IP phone dialpad” on page 24.

4. Choose one of the following:



- Press the **Select** soft key to save the changes and return to the **Telephone Options** menu.
- Press the **Cancel** soft key to keep existing configurations.

### To restore the default labels:

To restore feature key labels, press the **Services** key, select **Telephone Options**, and select **Change feature key labels**.



5. Press the **Enter** key.



6. Use the **Up/Down** navigation keys to scroll and highlight one of the following:
  - a. Restore all key labels
    - Press the **Yes** soft key to change all feature keys to default values.
  - b. Restore one key label
    - Press the **Select** soft key.
    - Press the feature key.
    - Press the **Yes** soft key to change the selected feature key label to the default value.

**Note:** If labels are changed to default values, you cannot undo the change. The label configurations must be reentered.

### Configuring the name display format

You can configure your IP Phone 1140E to display the name of the incoming calling party in the following formats:

- first name, last name
- last name, first name

To configure name display format, press the **Services** key, select **Telephone Options**, and select **Name Display Format**.

**To configure name display format:**



1. Press the **Up/Down** navigation keys to scroll and highlight **Name display format**.



2. Press the **Enter** key.



3. Press the **Up/Down** navigation keys to scroll and highlight one of the following:
  - **first name, last name**
  - **last name, first name**

4. Choose one of the following:



- Press the **Select** soft key to save the configuration.
- Press the **Cancel** soft key to keep existing configurations.

## Configuring Live Dialpad

The Live Dialpad option activates the Primary DN key when you make a call by dialing a directory number on the dialpad without picking up the handset or pressing the handsfree key.

To configure Live Dialpad, press the **Services** key, select **Telephone Options**, and select Live Dialpad.

### To configure Live Dialpad:



1. Press the **Up/Down** navigation keys to scroll and highlight **Live Dialpad**.



2. Press the **Enter** key.



3. Press the **Up/Down** navigation keys to scroll and highlight one of the following:

- **On**
- **Off** (default)

4. Choose one of the following:

- Press the **Select** soft key to save the configuration.
- Press the **Cancel** soft key to keep existing configurations.

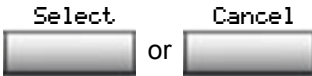

# Configuring Local Menu options

**Note:** Many of the options discussed in this section are for administrator use only. Do not make any changes unless instructed by an administrator.

Your system administrator can establish a password for the Local Tools menu. When the password is enabled, a password prompt dialog box appears when you attempt to access this menu. If this happens, contact your system administrator.

Your IP Phone 1140E has both local and server-based options. Press the **Services** key twice to access the Local Tools menu, which is organized into the following submenus:

- “Using the 1. Preferences submenu” on page 56
- “Using the 2. Local Diagnostics submenu” on page 77
- “Using the 3. Network Configuration menu” on page 78
- “Using the 4. Lock Menu” on page 78

If a menu entry has a number in front of it, you can select that entry by pressing the associated key on the dialpad. For example, in the Local Tools menu, you can access **2. Local Diagnostics** by pressing the 2 key on the dialpad.

The function of some keys on the IP Phone varies depending on the situation. The key functions in the menus are described in Table 4.

**Table 4: Navigation key functions in menus (Part 1 of 2)**

Key	Function
<b>Down</b> arrow keys	Move the highlight down
<b>Up</b> arrow keys	Move the highlight up
<b>Right</b> arrow key	Select the current menu item
<b>Left</b> arrow key	Close the menu
<b>Enter</b> key	Select the current menu item

**Table 4: Navigation key functions in menus (Part 2 of 2)**

Key	Function
Enter digits on the dialpad	Select the associated menu item
<b>Stop</b> soft key	Close the menu

The key functions in dialog boxes are described in Table 5.

**Table 5: Navigation key functions in dialog boxes**

Key	Function
<b>Down</b> arrow keys	Scroll the window down
<b>Up</b> arrow keys	Scroll the window up
<b>Right</b> arrow key	Go to the next Edit item
<b>Left</b> arrow key	Go to the previous Edit item
<b>Enter</b> key	Toggle Edit mode on or off Toggle the check box status

If you are working in Edit mode, the first field of the item is highlighted and a blinking cursor is to the right of the current edit position. The navigation key functions in Edit mode are described in Table 6.

**Table 6: Navigation key functions in Edit mode (Part 1 of 2)**

Key	Function
<b>Down</b> arrow keys	Open the list Move the highlight down the list
<b>Up</b> arrow keys	Move the highlight up list
<b>Right</b> arrow key	Select the current list item Move the cursor to the right
<b>Left</b> arrow key	Delete a character in the edit field

**Table 6: Navigation key functions in Edit mode (Part 2 of 2)**

Key	Function
Enter key	Select the highlighted item in the Exit edit mode box
Enter characters or digits on the dialpad	Insert characters or digits at the current cursor position

If you are using a USB mouse, you can right-click on the Telephony screen to open the Local Tools menu, and click on an item to select it.

## Using the 1. Preferences submenu

The Local Tools menu **1. Preferences** submenu offers the following choices:

- “Changing 1. Display Settings” on page 56
- “Changing 2. Language” on page 57
- “Configuring 3. Headsets” on page 58
- “Configuring 4. Bluetooth” on page 65

### Changing 1. Display Settings

The Display Settings menu provides access to two tools: **Contrast** and **Sleep**. Use the **Contrast** tool to alter the physical settings of the display. Use the **Sleep** tool to control how long the display remains lit if the phone is inactive.

**Note:** Changes you make to contrast in this menu are lost if the phone is reset. To avoid losing your changes, Nortel recommends that you use the Contrast Adjustment control in the Telephone Options menu.

To adjust Contrast or Sleep settings, press the **Services** key twice to open the Local Tools menu, press the 1 key on the dialpad to select **1. Preferences**, and press the 1 key on the dialpad to select **1. Display Settings**.



To adjust Contrast or Sleep settings:



1. Press the **Up/Down** arrow keys to scroll and highlight one of the following:
  - **Contrast**
  - **Sleep**

Sleep appears in the format xxx, where xxx is a time in minutes or hours.



2. Press the **Enter** key.



3. Press the **Up/Down** arrow keys to increase or decrease the selected value.

Available values for Sleep are as follows:

5m (5 minutes)

15m (15 minutes)

30m (30 minutes)

1h (1 hour — default)

2h (2 hours)

Never (screen does not go black)

**Note:** Extending the sleep time, or setting it to Never, reduces the life span of the display screen.

Exit



4. Press the **Exit** soft key to exit to the main display. Changes are saved automatically.

## Changing 2. Language

Use the Preferences menu item to configure local preferences. Use the **Language** tool to select the language used on your phone.

**Note:** This language setting controls the language used in the local menus on your phone only. To select the language used by features on your phone, press the **Services** key, select **Telephone Options**, and select **Language...**

To select the language used in the local menus, press the **Services** key twice to open the Local Tools menu, press the 1 key on the dialpad to select **1. Preferences**, and press the 2 key on the dialpad to select **2. Language**.

**To select the language used in local menus:**



1. Press the **Up/Down** navigation keys to scroll and highlight the desired language (for example, German [Deutsche]).

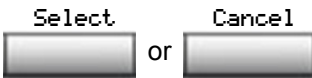

2. Choose one of the following:
  - Press the **Select** soft key to save the desired language and return to the **Telephone Options** menu.
  - Press the **Cancel** soft key to keep existing configurations.



3. Press the **Exit** soft key to exit to the main display. Changes are saved automatically.

## Configuring 3. Headsets

### Selecting Active Headset Device

To select the Active Headset Device, press the **Enter** key. Press the **Up/Down** navigation keys to select the desired headset.

## To select the active headset device



1. Press the **Up/Down** navigation keys to scroll and highlight the **Headsets** menu.



2. Choose one of the following:
  - Press the **Apply** soft key to save the desired headset and return to the **Telephone Options** menu.
  - Press the **Cancel** soft key to keep existing configurations.

**Note:** You can select a headset regardless of its connection status. It does not have to be physically connected to the IP Phone 1140E.



3. Press the **Cancel** soft key to exit to the main display. Changes are saved automatically.

## Enabling HID Commands

To enable HID Commands, press the **Right/Left** navigation key to open the Local Tools menu, press the 1 key on the dialpad to select **1. Preferences**, and press the 3 key on the dialpad to select **3. Headsets**.

### To enable HID Commands:



1. Press the **Up/Down** navigation keys to scroll and highlight the **Headsets** menu.

2. Select the **Enable HID Commands** checkbox.

3. Choose one of the following:

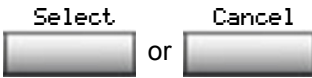

- Press the **Apply** soft key to save the desired selection and return to the **Telephone Options** menu.
- Press the **Cancel** soft key to keep existing configurations.



4. Press the **Cancel** soft key to exit to the main display. Changes are saved automatically.

### Enabling USB Headset

The wireless USB headset support included in UNISlim firmware release 3.1 for IP Phones is the Jabra GN9330E USB4 and the Plantronics CS50-USB and CS60-USB. The Plantronics CS50-USB utilizes 900MHz wireless technology whereas the Plantronics CS60-USB and Jabra GN9330E USB utilize 1.9Mz DECT wireless technology. These wireless headsets provide wireless freedom typically in the range of 60 meters or 200 feet. The actual distance allowed, before acceptable audio quality is threatened, is dependant on the operating environment.

Included in the support of the Jabra and Plantronics headsets is compliance to GN Netcom's and Plantronic's USB Human Interface Device (HID) respectively. Compliance to their HID allows the phone to recognize call controlling features from the headset including off-hook (call answer/call initiate), on-hook (call release), mute, and volume control.

### To enable USB headset

1. Select the **Headset** option in the **Preferences** menu of the IP Phone 1120E, IP Phone 1140E, and IP Phone 1150E. See the following Figure.



Making a change in the **Headset** menu page will take affect immediately, but only temporarily depending on what further action is taken.

2. Press the **Apply** button to make the changes permanent.
3. Press **Cancel** button to discard any changes.



4. Select the appropriate headset type in the **Active Headset Device** field from a list of Wired, USB, or Bluetooth as depicted in the following figure.

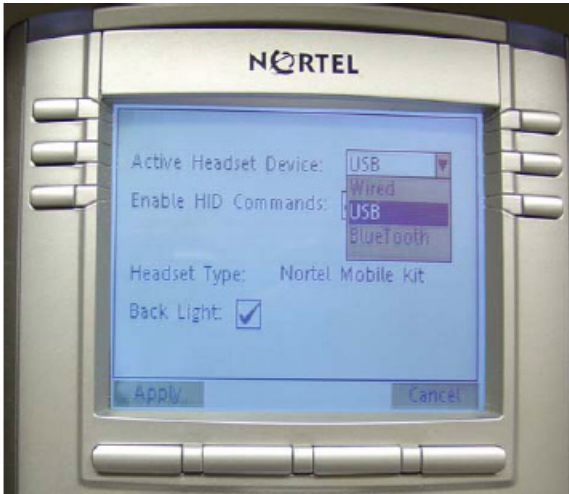

5. Select the **Enable HID Commands** check box to provide full HID for supported headsets.
6. Select the Headset type from the following list of headsets.
  - DuraPlus-B (GN Netcom DuraPlus Binaural Headset)
  - DuraPlus-M (GN Netcom DuraPlus Monaural Headset)
  - GN2020 (GN Netcom GN2020 NC Monaural Headset)
  - GN2100 (GN Netcom GN2100 Monaural Headset)
  - GN2115 (GN Netcom GN2115 ST Binaural Headset)
  - GN2117 (GN Netcom GN2117 ST Monaural Headset)
  - GN2125 (GN Netcom GN2125 NC Binaural Headset)
  - GN2220 (GN Netcom GN2220 NC Monaural Headset)
  - GN2225 (GN Netcom GN2225 NC Binaural Headset)
  - Nortel Handset

You can select the headset type and configure as the active headset device regardless of whether the headset is connected or not.

**Note:** You can select the Headset Type only for the Nortel USB Headset Adapters. If the Nortel USB Headset Adapter is not detected, the Headset Type selection is disabled and cannot be modified.

7. Select the **Back Light** check box to control the backlight on the Nortel USB Headset Adapters. This check box is selected by default.

**Note:** If the Nortel USB Headset Adapter is not detected this item is disabled and cannot be modified.



### Limitations and Advisories

- USB headsets consume power from the USB port in order to operate. The USB port on the IP Phone imposes a limit of only 100mA. The limit of 100mA is sufficient to power the Nortel USB Adapters but is not sufficient to power the wireless headsets from GN Netcom and Plantronics. Also 100mA is not sufficient to power the Algo 4900 USB ATA.
- USB Audio support does not include stereo audio.
- Changes have occurred regarding the provisioning of Bluetooth on the IP phone 1140E and 1150E. With UNiStim 3.1, the Bluetooth setup page no longer provides the option to select Bluetooth

headset since this choice has been moved to the Headset menu.

- Users of USB Audio on an IP Phone 1120E or IP Phone 1140E when connected to a BCM system may experience constant beeping from the wireless headsets if the user inadvertently hits a call control keys in error.
- For the Nortel USB Adapters it is a requirement that the firmware of this device be V2.0.32 or later.
- For the Algo 4900 USB ATA it is a requirement that the firmware of this device be v1.00.32 or later.
- The Algo 4900 USB ATA is classified as a high power USB device and must be connected to the phone through a powered USB hub.
- The Plantronics CS50-USB and CS60-USB must be AC powered prior to connecting them to phone.
- For the Plantronics CS50-USB and CS60-USB please make sure the headset base is in ready mode (i.e. the green LED on the right hand side of the headset cradle is solid) before using the headset.
- For the Plantronics CS50-USB and CS60-USB the On Hook/Off Hook button must be depressed for 3 seconds to go off hook.
- At the time of this writing, GN Netcom produces four models of the Jabra GN9300 series headsets: Jabra GN9330, Jabra GN 9330E, Jabra GN 9350 and Jabra GN9350E. The USB Audio feature in the IP Phones only supports the Jabra GN9330E and Jabra GN9350E connected via USB.
- For the GN Netcom 9300 series occasionally a single ring is lost between the phone and the headset but is recovered at the next ring.
- For the GN Netcom 9300 series occasionally a drop in audio quality may be experienced when a 3-way conference is established.

### **Nortel Mobile Headset Adapter properties**

You can use the Nortel Mobile Headset Adapter to answer calls whenever the IP Phone 1140E is running.

To access the Nortel Mobile Headset Adapter (MHA) properties, press the [Services](#) key twice to open the Local Tools menu, press the 1 key on



the dialpad to select **1. Preferences**, and press the 3 key on the dialpad to select **3.Headsets**.

**Note:** The Headset type and Backlight options are only available when MHA is attached.

Table 7 describes the features of the Nortel Mobile Headset Adapter.

**Table 7: Nortel Mobile Headset Adaptor elements and functions**

Key	Function
Answer key	Press to answer an incoming call.  If there is no incoming call, the IP 1140E handset selects a line and you hear a dial tone. This is also referred to as Off-hook.
Release/Goodbye key	This is also referred to as On-hook.
Mute key	Press the <b>Mute</b> key to listen to the receiving party without transmitting.  Press the <b>Mute</b> key again to return to two-way conversation.
Volume key	Use the Volume buttons to increase or decrease the volume of the headset.
Backlight	The backlight illuminates when you connect your headset to the IP Phone 1140E.

## Configuring 4. Bluetooth

Your IP Phone 1140E is equipped with a radio system to support Bluetooth wireless technology enabled headsets. Double press the **Headset** key to open the Bluetooth Setup dialog box. You must be

familiar with the operation of the navigation keys to work in the Bluetooth Setup dialog box; see the Navigation keys description on page 15.

The Bluetooth Setup menu entry is not available on all phones. If the Bluetooth Setup menu entry appears dimmed, or fails to open when you double press the Headset key, the feature is not enabled on your phone. Before you can use a wireless headset with your phone, the feature must be enabled by the system administrator. Contact your administrator to find out if Bluetooth wireless technology functionality is available for your use.

**Note:** Nortel recommends that you not pair more than one headset of the same model, because they have identical names in the Paired list.

### To pair a wireless headset with your phone:



(Headset)

1. Double-press the **Headset** key to open the Bluetooth Setup dialog box.

The **Enable Bluetooth** check box is highlighted.

If the Bluetooth Setup menu fails to open when you double press the Headset key, Bluetooth wireless technology feature is not enabled on your phone. Contact your administrator.



2. Press the **Enter** key to activate Bluetooth wireless technology.

A check mark is displayed on the **Enable Bluetooth** item to indicate that the Bluetooth wireless technology is activated. The message "Bluetooth Enabled" appears at the bottom of the display.

3. Put your Bluetooth technology headset in its pairing or search mode. The procedure for doing this can be different for each headset. Refer to the documentation that accompanied your headset, or contact the vendor.



4. Search devices.
  - a. Ensure that your headset is in Pairing or Search Mode.
  - b. Press the **Right** navigation key twice, and highlight the **Search** button, displayed next to the Search Devices item.
  - c. Press the **Enter** key.

The message "Searching..." appears. It can take up to two minutes for the search to complete.

If the search is successful, the message "Search Completed Found Device(s)" appears, and a list of devices that support Bluetooth wireless technology appears in the **Found**: list.

- d. Choose one of the following:
  - If the search is successful, proceed to step 5.
  - If the search is not successful, the message "Search completed. No device found" appears. If this happens, or if the headset times out and exits search/pairing mode, power off the headset, and repeat steps 3 and 4.

If pairing is still unsuccessful, pair the phone to another wireless headset, or contact the headset vendor.



5. When the name of your headset appears in the Found: box, press the **Stop** soft key or wait for the search to finish. When the search is complete, the message "Search Completed Found Device(s)" appears.

6. Choose one of the following:

- If the name of your headset appears in the **Found:** box, proceed to step 7.
- If your headset is not displayed in the **Found:** box, select your headset from the list, as follows:
  - a. Press the **Right** navigation key one or more times to highlight the **Found:** box. Press the **Enter** key to start the edit mode.
  - b. Press the **Down** navigation key to open the **Found:** list. Press the **Up/Down** navigation keys to scroll and highlight your headset.
  - c. Press the **Enter** key to select the headset and close the list. Press the **Enter** key to exit edit mode.





7. Press the **Right** navigation key one or more times to highlight the **Pair** button (next to the Pair Device item) and press the **Enter** key.
  - a. A dialog box appears, with the prompt "Enter PIN#".
  - b. Use the phone dialpad to enter the PIN for the wireless headset and press the **Enter** key.

Check your headset documentation to find its PIN (sometimes called a passkey). Typically this value is 0000.

8. Choose one of the following:
  - If the headset is successfully paired with your phone, proceed to step 9. To verify that the pairing was successful, ensure that the headset appears in the list next to the Paired: item. If pairing is successful, the message "Pair completed" also appears at the bottom of the screen.
  - If the headset is not successfully paired with your phone, an error message appears at the bottom of the screen. If an error message appears:
    - Confirm that the wireless headset is still in search/pair mode.
    - If the headset timed out and exited search/pairing mode, put the headset in pairing mode, as discussed in step 3, and repeat step 7.
    - Check that you are using the correct PIN and repeat step 7.

9. Choose one of the following:
  - If the name of your headset appears in the **Paired:** box, proceed to step 10.
  - If more than one device is paired, and the one you wish to use is not shown in the **Paired:** box, navigate to the one you want, as follows:
    - a. Press the **Right** navigation key one or more times to highlight the **Paired:** box. Press the **Enter** key to start the edit mode.
    - b. Press the **Up/Down** navigation keys to open the list. Press the **Up/Down** navigations key to scroll in the **Paired:** list and highlight your headset.
    - c. Press the **Enter** key to select the headset and close the list. Press the **Enter** key to exit edit mode.







10. Choose one of the following:

- If only one headset is paired, proceed to step 11.
- If more than one wireless headset is paired, the first headset paired is automatically made the active device. To make a different headset active, do the following.
  - Press the **Right** navigation key one or more times to highlight the **Set** button (next to the Set Active Device item).
  - Press the **Enter** soft key.

The message "Set active: "device name" appears. This means the headset named is now the active headset and is used when you press the headset key.

Exit



11. Press the **Exit** soft key to exit to the main display. Changes are saved automatically.

### Dual Pairing Headsets

Take special care when using a "dual pairing" type of Bluetooth wireless technology headset, which can be paired to its base as well as to the 1140E. If it is paired to both, the 1140E is the second device, and the following applies:

Press the headset "telephone" key:

- If a single tone sounds, the headset is connected to the base.
- If a double beep sounds, the headset is connected to the 1140E.

If the base is powered off, the headset is only paired to the 1140E and pressing the "telephone" key connects you to the 1140E.

**Note:** Unless you need to dual pair a headset, operating the headset with the 1140E is simpler if the headset is only used with its charging-only base. The desktop IP Phone base should be powered off if it is not in use.

### Interaction with wired headsets

If you connect a Bluetooth wireless technology headset and a wired headset to the same IP Phone 1140E, the “Use Bluetooth headset” item switches between the wired headset and the Bluetooth headset. If you select the “Use Bluetooth Headset” check box, the Bluetooth headset provides the audio. If you clear the “Use Bluetooth Headset” check box, the wired headset provides the audio.

The Bluetooth wireless technology headset can work only if it is within range of the phone; as the wireless headset approaches the edge of its radio range, the audio quality degrades and radio interference noise increases. When the wireless headset is in connecting range, the **Headset** key controls the wireless headset, even if a wired headset is attached. If a wireless headset moves out of connecting range, a special beep sounds in the headset indicating the connection was lost.

### When you do not want to use your Bluetooth technology headset

If a Bluetooth wireless technology headset is connected, and you want to use the wired headset, you can switch between the two. It is not necessary to unpair or disable the wireless headset.

You can switch between a wired and wireless headset and back again either when the phone is idle or during an active call.

### To switch between a wired headset and a wireless headset:



(Headset)

1. Double-press the **Headset** key to open the Bluetooth Setup dialog.



2. Press the **Left/Right** navigation key to select the “Use BT Headset” item.



3. Press the **Enter** key to toggle this option on or off.

A check mark indicates that the wireless headset is used. Clear the check mark to use a wired headset. This option is on (✓) by default.

### To unpair a wireless headset:



(Headset)

1. Double-press the **Headset** key to open the Bluetooth Setup dialog box.



2. Press the **Right** navigation key to select the Paired: item.

3. Choose one of the following:
  - If the name of your headset appears in the Paired box, proceed to step 5.
  - If more than one device is paired, and your headset is not already displayed in the Paired box, do the following:
    - a. Press the **Right** navigation key one or more times to highlight the Paired: box. Press the **Enter** key to open edit mode.
    - b. Press the **Up/Down** navigation keys to open the list. Press the **Up/Down** navigations key to scroll in the list and highlight your headset.
    - c. Press the **Enter** key to select the headset and close the box. Press the **Enter** key to exit edit mode.



4. Press the **Right** navigation key one or more times to highlight the UnPair button (next to the UnPair Device item).
5. Press the **Enter** key.

Your Bluetooth wireless technology headset is unpaired and removed from the Paired: item list.

Your Bluetooth wireless technology headset is no longer paired with your phone, and the wired headset can be used. To use the wireless headset again, you must perform the pairing and activation procedure.

## Using the 2. Local Diagnostics submenu

---

The Local Tools menu **2. Local Diagnostics** submenu offers the following choices:

- “Using 1. IP Set&DHCP Information” on page 77
- “Using 2. Network Diagnostic Tools” on page 77
- “Using 3. Ethernet Statistics” on page 77
- “Using 4. IP Network Statistics” on page 77
- “Using 5. USB Devices” on page 78

Press the **Return** soft key at any time while working with tools in the Local Diagnostics submenu to return to the Local Diagnostics submenu. Use the **Return** key in this way to quickly gather information and run tests without exiting and reentering the Local Tools menu. For example, you can check the Ethernet Statistics, then press **Return** and enter the Network Diagnostics Tools to ping an IP address.

### Using 1. IP Set&DHCP Information

The Network Configuration tool is used to view reports about IP set and DHCP operation. This tool is for administrator use only.

### Using 2. Network Diagnostic Tools

The Network Diagnostic Tools menu contains tools that are used to diagnose network problems. This menu is for administrator use only.

### Using 3. Ethernet Statistics

The Ethernet Statistics tool is used to view reports about Ethernet operation. This tool is for administrator use only.

### Using 4. IP Network Statistics

The IP Networks Statistics tool is used to view reports about network operation. This tool is for administrator use only.

### Using 5. USB Devices

The USB Devices tool provides information about any Universal Serial Bus (USB) devices that you connect to your phone. Your IP Phone 1140E automatically detects USB devices when you connect them to the USB port in the back of the IP Phone.

To check USB device information, press the **Services** key twice to open the Local Tools menu, press the 2 key on the dialpad to select **2. Local Diagnostics**, and press the 5 key on the dialpad to select **5. USB Devices**.

**To check USB device information:**

The screen displays information about connected devices.

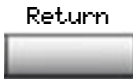

1. Press the **Return** soft key to return to the main display.

### Using the 3. Network Configuration menu

---

The Network Configuration tool displays information that was configured when the IP Phone was installed. This tool is for administrator use only.

### Using the 4. Lock Menu

---

Your system administrator can use the lock menu tool to protect the Local Tools menu items from accidental or unwanted changes. This tool is for administrator use only.

# Making a call

This section describes features associated with making a call. You can make a call from your IP Phone 1140E using any of the following:

- “Using Off-hook dialing” on page 79
- “Using On-hook dialing” on page 80
- “Using handsfree dialing” on page 81
- “Using the Directory applications” on page 83
- “Using Predial” on page 86
- “Using AutoDial” on page 87
- “Using Ring Again” on page 89
- “Using Last Number Redial” on page 90
- “Using Speed Call” on page 90
- “Using System Speed Call” on page 92
- “Using HotLine” on page 92
- “Using intercom calling” on page 92

## Using Off-hook dialing

---

Use these steps to make a call by lifting the handset before dialing:



1. Lift the handset.



2. Dial the number.



3. To terminate the call, choose one of the following:
  - Return the handset to the cradle.
  - Press the **Goodbye** key.

## Using On-hook dialing

Use these steps to make a call by dialing before lifting the handset:

1. Leave the handset in the cradle.

2493 

2. Press the line (DN) key.



3. When the dial tone sounds, dial the number.



4. When the called party answers, lift the handset.



5. To terminate the call, choose one of the following:
  - Replace the handset into the cradle.
  - Press the **Goodbye** key.



## Using handsfree dialing

Use handsfree dialing to use a built-in microphone and speaker, or a headset, instead of the handset. While on an active call, you can switch between handset and handsfree mode.



or

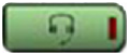

1. Choose one of the following:
  - Press the **Handsfree** key.
  - If a headset is connected, press the **Headset** key.



2. Dial the number.

### To discontinue a handsfree call:



(Goodbye)

Press the **Goodbye** key.

### To mute a handsfree call:



(Mute)

1. Press the **Mute** key. The LED indicator flashes.



(Mute)

2. Press the **Mute** key again to return to a two-way handsfree conversation.

### To switch from handsfree to handset mode:



Lift the handset.

### To switch from handset mode to handsfree mode:



1. Press the **Handsfree** key.



2. Replace the handset.

### To use a headset:

1. Connect the headset to the headset jack or the handset jack.



2. Press the **Headset** key.

If you have a Bluetooth wireless technology headset installed, you can activate it by pressing the button on the headset.

### To release a call:



(Goodbye)

1. Press the phone **Goodbye** key or press the button on the wireless headset, if equipped.

To switch from handsfree to headset:



1. Press the **Headset** key.

## Using the Directory applications

---

You can make calls using the following Directory applications available on your IP Phone 1140E.

- “Making a call using the Corporate Directory” on page 83
- “Making a call using the Personal Directory” on page 84
- “Making a call using the Callers List” on page 85
- “Making a call using the Redial List” on page 86

### Making a call using the Corporate Directory

This feature is not available on all phones. Contact your system administrator to find out if this feature is available for your use.

The Corporate Directory feature provides an alphabetical list of entries using last names. You can search by name, view additional information on each entry, and dial Corporate Directory numbers. To use the Corporate Directory, press the **Directory** key and select **Corporate Directory**.

To search for a specific number:



1. When prompted, use the dialpad to enter the desired name in the last name, first name format.

Search



2. Press the **Search** soft key to find the desired name.

If the search is successful, the first match appears on the screen.

Dial



Cancel



3. Choose one of the following:
  - Press the **Dial** soft key to dial the resulting number.
  - If there is no match to the search query, start a new search or change the information in the initial search.
  - Press the **Cancel** soft key to exit without dialing.

### To scroll to a specific number:



1. Press the **Up/Down** navigation keys to scroll and highlight a name in the Corporate Directory.

2. Choose one of the following:

Dial



or

Cancel



- Press the **Dial** soft key to dial the resulting number.
- Press the **Cancel** soft key to exit without dialing.

## Making a call using the Personal Directory

The Personal Directory feature allows you to store a maximum of 100 entries consisting of names and numbers. To use the Personal Directory, press the **Directory** key and select **Personal Directory**. For more information on how to configure and use the Personal Directory, refer to “Using the Personal Directory” on page 133.

### To make a call using the Personal Directory:



1. Press the **Up/Down** navigation keys to scroll and highlight a name in the **Personal Directory**.

2. Choose one of the following:

- Press the **Dial** soft key to dial the resulting number.
- Press the **Cancel** soft key to exit without dialing.



### Making a call using the Callers List

The Callers List feature automatically stores up to a maximum of 100 callers. After 100 callers have been stored, each additional caller overwrites the oldest entry. To use the Callers List, press the **Directory** key and select **Callers List**. For information on how to configure and use the Callers List, refer to “Using the Callers List” on page 136.

### To make a call using the Callers List:



1. Press the **Up/Down** navigation keys to scroll and highlight a name in the **Callers List**.

2. Choose one of the following:

- Press the **Dial** soft key to dial the resulting number.
- Press the **Cancel** soft key to exit without dialing.



### Making a call using the Redial List

The Redial List feature automatically stores a maximum of 20 previously dialed phone numbers. To use the Redial List, press the **Directory** key and select **Redial List**. For information on how to configure and use the Redial List, refer to “Using the Redial List” on page 138.

**To make a call using the Redial List:**



1. Press the **Up/Down** navigation keys to scroll and highlight a name in the **Redial List**.

2. Choose one of the following:

- Press the **Dial** soft key to dial the resulting number.
- Press the **Cancel** soft key to exit without dialing.



### Using Predial

---

Use the Predial feature to enter, preview, and edit numbers before dialing.

**To use Predial:**



1. Without selecting the line key, enter the number to be dialed.



2. Press a line key to dial the number.



3. Lift the Handset when the called party answers or, if in handsfree mode, begin to speak.

### To edit a Predial number:



1. Use the dialpad to enter the number.

2. Choose one of the following:

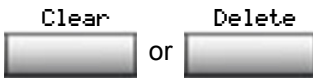

- To erase all numbers, press the **Clear** soft key. Reenter the numbers to be dialed.
- To change one number at a time, press the **Delete** soft key to backspace. Re-enter the number.



3. Press a line key to dial the number.

## Using AutoDial

Use the AutoDial feature to display, store, and automatically dial phone numbers.

### To store an AutoDial number:

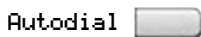

1. Without lifting the handset, press the appropriate **AutoDial** key.

The screen displays the word Autodial next to the appropriate key.



2. Using the dialpad, dial the phone number (including access code) to be stored on the selected **AutoDial** key.

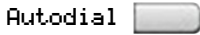

3. Press the **AutoDial** key a second time to store the number on the selected key.

After you store a number, the word Autodial disappears, and the stored number appears.

4. Assign a label to the key.

After you assign the label, the number disappears and only the label appears on the screen next to the key.

### To display an AutoDial number:



1. Press the **Display** key.

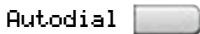

2. Press an **AutoDial** key in the upper display area to display the number associated with that key.

### To use AutoDial:



1. Lift the handset.

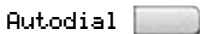

2. Press an **AutoDial** key in the upper display area to dial the number associated with that key.



## Using Ring Again

Use the Ring Again feature if you receive a busy tone, or if there is no answer. Your IP Phone rings when the person you called becomes available. Ring Again automatically redials the number.

### To activate Ring Again:



1. Dial a number and receive a busy tone or no answer.

Ring Again



or



2. Choose one of the following:
  - Press the **Ring Again** soft key.
  - Enter the **Ring Again Activate** FFC.

### To call a Ring Again party when you receive notification:



1. After receiving the notification ring, lift the handset, or, if you are using the headset or in handsfree mode, go to step 2.

Ring Again



2. Press the **Ring Again** soft key to automatically dial the number.

### To deactivate Ring Again before notification:

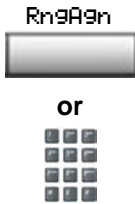

Choose one of the following:

- Press the **Ring Again** soft key a second time.
- Press the **Ring Again Deactivate** FFC.

## Using Last Number Redial

---

Use the Last Number Redial feature to automatically redial the last dialed number.

### To use Last Number Redial:

Choose one of the following:

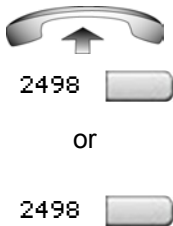

— To redial using the handset:

- a. Lift the handset.
- b. Press the line (DN) key.

— To redial without lifting the handset, press the line (DN) key twice (the last number dialed is automatically redialed).

## Using Speed Call

---

Use the Speed Call feature to place internal and external calls by dialing a one-, two-, or three-digit code to store, edit, and automatically dial frequently called phone numbers.

To store a Speed Call number:



1. Press the **Speed Call Controller** soft key. The triangular icon flashes, indicating programming mode.



2. At the prompt:
  - Enter a one-, two-, or three-digit code (0-999).
  - If required, dial the access code.
  - Enter the phone number (internal, external, or long-distance number).



3. Press the **Speed Call Controller** soft key again to save the code and number. The flashing icon turns off.

To make a Speed Call:



1. Lift the handset.



2. Press the **Speed Call Controller** soft key.



3. Dial the **Speed Call** code to automatically dial the number.

## Using System Speed Call

---

Use the System Speed Call feature to dial Speed Call codes that override dialing restrictions placed on your IP Phone.

**To make a System Speed Call:**



1. Lift the handset.

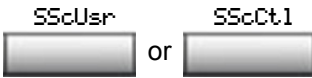

2. Choose one of the following:

- Press the **System Speed Call** soft key.
- Press the **System Speed Call Controller (SScCtl)** soft key.



3. Dial the **Speed Call** code to automatically dial the number.

## Using HotLine

---

Use the Hot Line feature to automatically dial a specific number.

**To use HotLine:**



Press the **HotLine** soft key to automatically dial the number.

## Using intercom calling

---

Use the Intercom feature to call a member of your intercom group by pressing the code assigned to each member.

To make an intercom call:



1. Lift the handset.



2. Press the **Intercom** key.



3. Dial the one- or two-digit code for the desired intercom group member.

To answer an intercom call while on a line other than your intercom group line:



(Hold)

or



(Goodbye)

1. Choose one of the following keys:
  - Press the **Hold** key to put the current call on hold.
  - Press the **Goodbye** key to end the call.



2. Press the **Intercom** key and begin to speak.

# Answering a call

Each incoming call causes the IP Phone to ring, the LCD indicator (  ) beside the line (DN) key to flash, and the Message Indicator lamp to flash.

## To answer a call:

Choose one of the following four options:



or



or



or



- Lift the handset.
- Press the **Handsfree** button located on the left side of the handset.
- Press the line (DN) key beside the LCD indicator as it flashes.
- Press the **Headset** key if a headset is connected to your IP Phone.

## While on an active call

You can use the following features during an active call:

- “Placing a call on hold” on page 95
- “Transferring a call” on page 96
- “Using Timed Reminder Recall” on page 97
- “Using Attendant Recall” on page 98
- “Using Call Park” on page 98
- “Recording a Calling Party Number” on page 101
- “Displaying incoming calls” on page 101
- “Tracing a malicious call” on page 102

### Placing a call on hold

---

Use the Hold feature when you are talking on one line and another call arrives on a second line. To retain the original call, put it on hold and then answer the second call.

**To place a call on hold:**



Press the **Hold** key. The LCD indicator flashes beside the line on hold.

**Note:** If **Automatic Hold** is enabled, the active call is automatically put on hold when you answer the second call.

**To retrieve a call on hold:**



Press the line (DN) key beside the flashing LCD indicator.

## Transferring a call

---

Use the Transfer feature to redirect a call to the appropriate person.

### To transfer a call to a third party:



1. Press the **Transfer** soft key. The other party is put on hold and a dial tone sounds. The LCD indicator light flashes steadily.



2. Dial the DN number to which you are transferring the call or use the **Personal Directory**, **Redial List**, or **Callers List** to select a number to dial.



3. When that number rings or a person answers, press the **Transfer** soft key to connect the calling party.

### To return to the original call if the transfer is incomplete:



If the person called is not available, press the line (DN) key (next to the LCD indicator) to reconnect to the original call.



## Using Timed Reminder Recall

Use the Timed Reminder Recall feature to receive a reminder tone when a transferred call is not answered.

### To use Timed Reminder Recall:



1. Press the **Transfer** soft key. The call is put on hold.



2. Dial the number to which you are transferring the call.



3. Choose one of the following to start the recall timer:

or

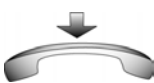

- Press the **Transfer** soft key.
- Replace the handset before the extension answers.

If the transfer is complete, the recall timer stops.

### If the transferred call is not answered, your IP Phone rings:



1. Lift the handset to reconnect to the original caller.



2. Choose one of the following:
  - Press the **Transfer** soft key and repeat the transfer.
  - If the transfer is picked up while you are on the line, press the **Goodbye** key to complete the transfer.

## Using Attendant Recall

---

Use the Attendant Recall feature to contact an attendant during a call and to connect the caller to the attendant.

**To contact the attendant while on a call:**

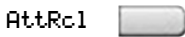

1. Press the **Attendant Recall** key and stay on the line until the attendant answers.

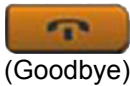

2. Press the **Goodbye** key. The caller remains connected to the attendant.

## Using Call Park

---

Use the Call Park feature to hold temporarily (park) and retrieve a call from any IP Phone. Using Call Park does not tie up a line. When configured network-wide, Call Park can be used across networks. A System Park extension can be configured to automatically park most calls.

**To park a call on the System Park DN or your own DN:**



During an active call, press the **Park** soft key twice.

The call is parked on your DN unless a **System Park DN** is enabled to automatically park calls on the system.

**To park a call on a DN other than the System Park DN or your own DN:**



1. Press the **Park** soft key.



2. Dial the DN where you want to park the call.



3. Press the **Park** soft key.

**To park a call using the SPRE code or FFC:**

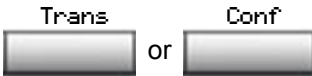

1. Choose one of the following:

- Press the **Transfer** soft key.
- Press the **Conference** soft key.



2. Dial the **Call Park** FFC.



3. To use an alternate DN from the **System Park** DN or your own DN, dial the DN where you want to park the call. Otherwise, proceed to step 4.

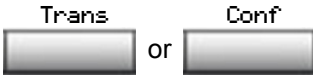

4. Choose one of the following:
  - Press the **Transfer** soft key.
  - Press the **Conference** soft key.

**To retrieve a parked call:**



1. Lift the handset.



2. Press the **Park** soft key.



3. Dial the DN where you parked the call.  
If a parked call is not retrieved within a specified period of time, it rings back to your IP Phone or to the attendant.

## Recording a Calling Party Number

---

Use the Calling Party Number feature to record a caller number, or to charge a call to an account number, during an established call.

To record a caller number for accounting purposes:



1. Press the **Call Party** soft key. The caller is placed on hold.



2. Dial a charge account number or the caller number.

**Note:** For information on using the **Charge** soft key, see “Charging a call or charging a forced call” on page 123.



3. Press the **Call Party** soft key to return to the call.

## Displaying incoming calls

---

Use the Display feature to display a second incoming caller number and name (if available) during an active call, without interfering with the call in progress.

To view the information on an incoming call while on a call in progress:



1. Press the **Display** key.



2. Press the flashing line (DN) key. The call waiting information appears.

If you are using another feature key, you can use the **Display** key to access information associated with those feature keys.

## Tracing a malicious call

Use the Call Trace feature to trace nuisance calls within your system.

This feature is not enabled on all IP Phone 1140Es. Contact your system administrator to configure this feature on your IP Phone.

### To use Call Trace while on a call:



Press the **Call Trace** key.

### To use Call Trace without a Call Trace key:

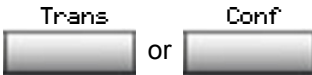

1. Choose one of the following:
  - Press the **Transfer** soft key.
  - Press the **Conference** soft key.
2. Dial the **SPRE code** followed by **83** or dial the **Call Trace** FFC to automatically reconnect.



# Incoming calls

You can use the following features when you have an incoming call:

- “Using Automatic Answerback” on page 103
- “Using Call Pickup” on page 103
- “Using Call Waiting” on page 105

## Using Automatic Answerback

---

When the Automatic Answerback feature is active, your IP Phone automatically answers in Handsfree mode after one ring; however, calls are *not* forwarded to the voice message service.

**To activate Automatic Answerback:**

AutoAns



Press the **Automatic Answerback** key.

**To deactivate Automatic Answerback:**

AutoAns



Press the **Automatic Answerback** key again.

## Using Call Pickup

---

Use the Call Pickup feature to pick up calls from any IP Phone in your pickup group or another pickup group.

**To answer a call in your own call pickup group:**



1. Lift the handset.

Pickup 

or



2. Choose one of the following:

- Press the **Pickup** key.
- Enter the **Pickup Ringing Number** FFC.

### To answer an incoming call in another call pickup group:



1. Lift the handset.

GrPpkP 

2. Choose one of the following:

- Press the **Group Pickup** soft key.
- Enter the **Pickup Group** FFC.



3. Dial the pickup group number of the ringing IP Phone.

### To answer a call at a specific extension in any pickup group:



1. Lift the handset.

Pickup 

or



2. Choose one of the following:

- Press the DN **Pickup** key.
- Enter the **Pickup Directory Number** FFC.





3. Dial the DN of the IP Phone that is ringing (and that is not in your call pickup group). If the pickup DN or group number is invalid (an overflow burst tone sounds and the screen displays *Goodbye and try again*), press the **Goodbye** key.

## Using Call Waiting

The Call Waiting feature alerts you to an incoming call by producing a tone. It also puts the current call on hold while you answer the new call.

### To answer an incoming call while on another call:



1. When the incoming call tone sounds, press the **Hold** key to put a current call on hold.

If **Automatic Hold** is enabled, you do not need to press the **Hold** key.



2. Press the **Call Waiting** key.

### To return to the first IP Phone call:



(Hold)  
or



(Goodbye)

1. Choose one of the following:
  - Press the **Hold** key to put the second call on hold.
  - Press the **Goodbye** key to end the second call.



2. Press the line (DN) key associated with the first call.

### If you do not have a Call Waiting key:



(Goodbye)

1. Press the **Goodbye** key to end the current call.



2. Press the line (DN) key beside the flashing status icon to answer the incoming call.

# While away from your desk

You can use the following features when you are away from your desk:

- “Using Call Forward” on page 107
- “Using Internal Call Forward” on page 108
- “Using Remote Call Forward” on page 109
- “Securing your IP Phone” on page 111

## Using Call Forward

Use the Call Forward feature to direct incoming calls to ring on another line (DN). If the IP Phone is in the process of ringing, the call cannot be forwarded.

**To forward your calls or change the forward number:**

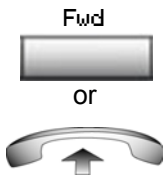

1. Choose one of the following:
  - Press the **Forward** soft key.
  - Lift the handset and enter the **Call Forward All Calls Activate FFC**.



2. Dial the DN where you want to forward your calls.



3. Press the **Forward** soft key.

To deactivate Call Forward:

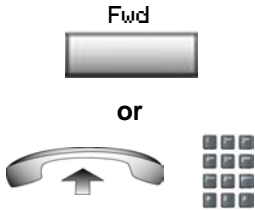

Choose one of the following:

- Press the **Forward** soft key.
- Lift the handset and enter the **Call Forward All Calls Deactivate** FFC.

To reinstate Call Forward to the same number:



Press the **Forward** soft key twice.

## Using Internal Call Forward

---

Use Internal Call Forward to accept only calls originating at internal DNs to ring at another DN. Calls originating outside your IP Phone system still ring at your IP Phone. Current incoming calls cannot be forwarded.

To forward internal calls:

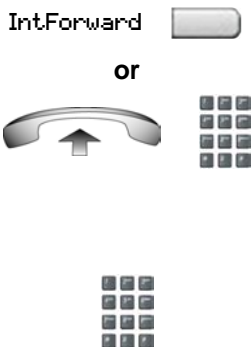

1. Choose one of the following:

- Press the **Internal Call Forward** key.
- Lift the handset and enter the **Internal Call Forward Activate** FFC.

2. Dial the DN to which you are forwarding your internal calls.

IntForward  3. Press the **Internal Call Forward** key.

### To deactivate Internal Call Forward:

IntForward 

or



Choose one of the following:

- Press the **Internal Call Forward** key.
- Lift the handset and enter the **Internal Call Forward Deactivate FFC**.

### To reinstate Call Forward to the same number:

IntForward  Press the **Internal Call Forward** key twice.

IntForward 

## Using Remote Call Forward

Use the Remote Call Forward feature (from any IP Phone other than your own) to forward calls to any IP Phone.

### To activate Remote Call Forward:



1. Lift the handset.



2. If you are calling from an IP Phone outside the system, dial your direct system access number and wait for the dial tone.



3. Dial the **Remote Call Forward Activate FFC** to activate the feature.



4. Dial your **Station Control Password**. A dial tone sounds.



or



5. Choose one of the following:
  - Dial your DN.
  - To forward calls to the previous call forward phone number, press the **#** key. (Do not perform steps 6 and 7.)



6. Dial the number to which you are forwarding calls. If calls are forwarded to an invalid number, a fast busy signal sounds.



7. Press the **#** key.

### To deactivate Remote Call Forward:



1. Lift the handset.



2. If you are calling from an IP Phone outside the system, dial the **direct system access** number and wait for the dial tone.



3. Dial the **Remote Call Forward Deactivate** FFC.



4. Dial your **Station Control Password**.



5. After you hear the dial tone, dial your DN.



6. Press the **#** key.

## Securing your IP Phone

---

Use the Electronic Lock feature to prevent others from making calls from your IP Phone. The Electronic Lock feature is controlled using your Station Control Password (SCPW). To change your Station Control Password, refer to “Security features” on page 21.

### To lock your IP Phone:



1. Lift the handset.



2. Dial the **Electronic Lock Activate** FFC.



3. Dial your **Station Control Password**.



(Goodbye)

or



4. Choose one of the following:
  - If dialing locally, press the **Goodbye** key.
  - If dialing the FCC remotely, dial your DN.

**To unlock your IP Phone:**



1. Lift the handset.



2. Dial the **Electronic Lock Deactivate** FFC.



3. Dial your **Station Control Password**.



(Goodbye)

or



4. Choose one of the following:
  - If dialing locally, press the **Goodbye** key.
  - If dialing the FCC remotely, dial your DN.



# Talking with more than one person

Use the following features to enable conversations between more than two people:

- “Using the Call Join feature” on page 113
- “Setting up a conference call” on page 113
- “Using Conferee Selectable Display” on page 115
- “Using Group Call” on page 116

## Using the Call Join feature

---

Use the Call Join feature to connect a call to a current active call. This connection creates a conference between the two callers and yourself.

**To connect a call on hold (on a different line) to your current call:**



1. Press the **Conference** soft key.



2. Press the line key that has the number of the caller you want to connect to your current call.



3. Press the **Conference** soft key to join the person on hold to your conversation.

## Setting up a conference call

---

Use the Conference feature to set up a conference call for a maximum of three or six people, including yourself. The maximum number of people

the conference feature supports depends on the configuration of your IP Phone.

### To set up a conference call:



1. While on a call, press the **Conference** soft key to place the party on hold. You hear a dial tone.



2. Dial the number of the person you want to add to the conference call. You can talk privately to the person you are adding at this time.

**Note:** Instead of dialing a number, you can press the **Directory** key, and use the **Corporate Directory** or **Personal Directory**, **Redial List**, and **Callers List** to find and dial the number of the person you want to add to the conference call.



3. Press the **Conference** soft key a second time to conference all parties together.

**Note:** You can talk to either party privately, press the **Incalls** key to talk to the originator or press the **Conf** key to talk to the transfer number. Alternating between these two keys alternates between the two parties. This needs to be done before pressing the Conf key twice. This also assumes **AHA CLS - Automatic Hold**, is enabled on the handset.

If the person you attempt to add to the conference is unavailable:



(Goodbye)

1. Press the **Goodbye** key.



2. Press the line (DN) key beside the flashing status icon to return to your original call.

## Using Conferee Selectable Display

Use the Conferee Selectable Display feature to list active conferees and disconnect a conferee from the conference call.

To view active conferees:



1. While on a conference call, press the **Conferee Selectable Display** key to turn on the LCD indicator. Each key press changes the screen to show a different active conferee.

This action has no effect on the display of other IP Phones involved in the conference.



(Goodbye)

2. Press the **Goodbye** key. If configured, the **Conference Count Display** returns an updated total count of conferees. The LCD indicator turns off.

### To disconnect a conferee:



1. While on a conference call, press the **Conferee Selectable Display** key until the conferee you want to disconnect appears on the screen.



2. Press the **DN** key on which the conference call is established.



(Goodbye)

3. Choose one of the following:
  - For a single conferee, press the **Goodbye** key. If configured, the **Conference Count Display** returns an updated total count of conferees. The LCD indicator turns off.
  - For multiple conferees, repeat steps 1 and 2 until all conferees are disconnected. Then press the **Goodbye** key.

## Using Group Call

---

Use the Group Call feature to automatically call members of a predefined group, one at a time, until all members answer.

### To call group members:



1. Lift the handset.

GrpCl



2. Press the **Group Call** key or enter the **Group Call FFC**.
  - The feature automatically calls all group members. The icon flashes until all members answer.
  - The phone numbers of the group members appear on the display as they answer. When the last person answers, the **Group Call** indicator lights steadily.
  - When a person in your group is on a conference call or another group call, they are not connected to your group call.
  - After everyone in the group has answered, only the person who made the group call can put the call on hold.

### To answer a group call:



1. Lift the handset. Note the following about notification tones:
  - If you are on a call and receive three 10-second tones, this is the notification of a group call on your current extension.
  - If you are on a call on another line when a group call is made, you receive a long tone through the handset or speaker.
  - If you are already on a conference call or another group call, you do not receive notification of a group call.

### To end a group call:



(Goodbye)

Press the **Goodbye** key.

**Note:** When the person who made the group call disconnects, the call terminates for all members of the group. However, the members of the group call can disconnect from the call and not affect other members on the call.

# Working without interruption

This section describes features that provide uninterrupted work time.

## Using Make Set Busy

Use the Make Set Busy feature to make your IP Phone appear busy to all callers.

### To activate Make Set Busy:



Choose one of the following:

- Press the **Make Set Busy** key.
- Lift the handset and enter the **Make Set Busy Activate** FFC.

### To deactivate Make Set Busy:

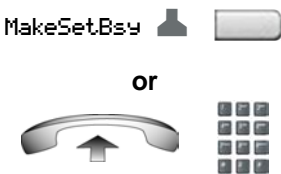

Choose one of the following:

- Press the **Make Set Busy** key a second time to deactivate the feature.
- Lift the handset and enter the **Make Set Busy Deactivate** FFC.

# Additional call features

Contact your system administrator to determine if the following call features are available on your IP Phone.

- “Using AutoDial Transfer” on page 120
- “Using the Buzz signal” on page 121
- “Using Call Page Connect to make an announcement” on page 121
- “Using Centrex/Exchange Line Switchhook Flash” on page 122
- “Charging a call or charging a forced call” on page 123
- “Using Enhanced Override” on page 126
- “Using Forced Camp-on feature” on page 127
- “Overriding a busy signal” on page 128
- “Using Privacy Release” on page 129
- “Using Radio Page” on page 129
- “Using Voice Call” on page 131

## Using AutoDial Transfer

---

Use the AutoDial Transfer feature to transmit digits through your AutoDial key to the Central Office after a Trunk Switchhook Flash. You must be on a Central Office/Exchange (CO) trunk call from or to a CO that offers Centrex or exchange line-type features.

**To use AutoDial Transfer when picking up an incoming trunk call:**

CentrexSHF 

1. Press the **Centrex Switchhook Line Flash** key and wait for an interrupted dial tone.

Autodial 

2. Press the **AutoDial** key to call the number desired.





(Goodbye)

3. Press the **Goodbye** key to end the call.

## Using the Buzz signal

---

Use the Buzz feature to notify another person of a call, a visitor, or a request. Two IP Phones that are linked together enable one person to signal the other. The person signaled hears a buzz.

**To buzz the IP Phone linked to your IP Phone:**

Buzz



Press the **Buzz** key. The IP Phone linked to your IP Phone buzzes as long as you press the key.

## Using Call Page Connect to make an announcement

---

Use the Call Page Connect feature to make an announcement over a paging system.

**Note:** A **Page** key on an attendant console overrides and disconnects the IP Phones. The IP Phones must reaccess the page trunk.

**To connect to Call Page:**



1. Lift the handset.



2. Dial the **Page Trunk Access Code** to complete the connection to the page system.
3. Make your announcement.



(Goodbye)

4. Press the **Goodbye** key.

## Using Centrex/Exchange Line Switchhook Flash

---

Use the Centrex/Exchange Line Switchhook Flash feature during an established call to use a Centrex service, such as Call Transfer or Three-Way Calling.

### To use Centrex/Exchange Line Switchhook Flash:

CentrexSHF

1. While on a call, press the **Centrex Line Switchhook Flash** key. A special dial tone sounds.



2. Dial the codes for your custom **Centrex** feature.



(Goodbye)

3. Press the **Goodbye** key to end the call.

## Charging a call or charging a forced call

Use the Call Charge feature to charge a call to a specific account. The Forced Charge feature charges long-distance calls from an IP Phone restricted to local calls.

**To charge a local or long-distance call to an account before you dial:**



1. Lift the handset.



2. Choose one of the following:

- Press the **Charge** soft key.
- Dial the **Call Detail Recording** FFC.



3. Dial the charge account number.



4. When the dial tone sounds, dial the number.

**To charge a call in progress:**



1. Choose one of the following:

- Press the **Transfer** soft key.
- Press the **Conference** soft key.



or



2. Choose one of the following:
  - Press the **Charge** soft key.
  - Dial the **Call Detail Recording** FFC.
3. Dial the charge account number.
4. Press the line (DN) key to return to the call.

### To charge a call to an account when you transfer a call:



or



1. Press the **Transfer** soft key. The call is placed on hold.
2. Choose one of the following:
  - Press the **Charge** soft key.
  - Dial the **Call Detail Recording** FFC.
3. Dial the charge account number.
4. After the dial tone, dial the number to which you are transferring the call.

Trans



5. Press the **Transfer** soft key when you hear the IP Phone ring.

You can talk privately to the person at the transfer number before you press the **Transfer** soft key.

**To charge a call to an account when you add someone to a conference call:**

Conf



1. Press the **Conference** soft key. The call is placed on hold.

Charge



or



2. Choose one of the following:
  - Press the **Charge** soft key.
  - Dial the **Call Detail Recording** FFC.



3. Dial the charge account number.



4. Dial the number of the person you want to add to the conference.



5. Press the **Conference** soft key.

**Note:** You can talk to either party privately, press the **Incalls** key to talk to the originator or press the **Conf** key to talk to the transfer number. Alternating between these two keys alternates between the two parties. This needs to be done before pressing the Conf key twice. This also assumes **AHA CLS - Automatic Hold**, is enabled on the handset.

## Using Enhanced Override

---

Use the Enhanced Override feature to override an active call after you attempt a Forced Camp-on. Use Enhanced Override to make a call or a consultation call, such as placing a call on hold and calling another party.

### To use Enhanced Override:



You receive a busy signal after dialing a phone number.

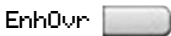

or



1. Choose one of the following:
  - Press the **Override** key.
  - Enter the **Override** FFC to initiate a Forced Camp-on.

If either person on the call disconnects at this time, you receive an overflow (fast busy or engaged) signal.

EnhOvr 

or



2. Choose one of the following:
  - Press the **Override** key again.
  - Enter the **Override** FFC again.

The other two people on the call receive an override tone and a conference call is established between the three of you. If anyone disconnects, the other two people remain connected.



(Goodbye)

3. To terminate the call, press the **Goodbye** key.

## Using Forced Camp-on feature

---

Use the Forced Camp-on feature to automatically ring another IP Phone (internal or external) immediately after that IP Phone disconnects from its current call.

### To use Forced Camp-on:



You receive a busy signal after dialing a phone number.

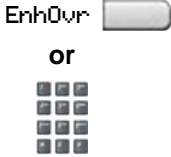

1. Choose one of the following:
  - Press the **Override** key.
  - Enter the **Override** FFC to initiate a Forced Camp-on.

The person you called receives a tone. You receive a ring signal or a busy signal, depending on the options chosen. You are now camped-on to the number you dialed.

2. Return the handset to the cradle.
3. When the person you called finishes the call, your IP Phone automatically dials the number and both IP Phones ring.

### Answering a call camped-on to your extension:



When your IP Phone rings, lift the handset.

You can program your IP Phone for either Camp-on or Call Waiting, but not both.

## Overriding a busy signal

---

Use the Override feature to override a busy signal and interrupt another call.

### To override a busy signal:



1. You receive a busy signal after dialing a phone number.



EnhOvr 

or



2. Choose one of the following:
  - Press the **Override** key.
  - Enter the **Override** FFC. The people in the targeted call receive a tone for approximately 1 second. After the Override feature joins you to the call, a short tone repeats every 16 seconds.



(Goodbye)

3. To terminate the call, press the **Goodbye** key.

## Using Privacy Release

---

Use the Privacy Release feature to enable one or more people who share your DN to join a call.

### To use Privacy Release in an established state:

PRVRls



Press the **Privacy Release** soft key during a call. People can join the call by pressing the shared number (DN) key on their IP Phone (Multiple Appearance DN feature).

## Using Radio Page

---

Use the Radio Page feature to page a person and stay on the line until they answer. The paged person answers the call after entering a special Page Meet-me code from any IP Phone.

### To use Automatic Preselection (Meet-me page):



1. Lift the handset.



2. Dial the **Radio Paging Access** FFC. The paging tone sounds (two beeps followed by a dial tone).



3. Dial the number of the party you want to page. After dialing, the ringback tone sounds.

The paged person can use any IP Phone to enter a **Radio Paging Answer** FFC, plus their own DN number.



(Goodbye)  
or

4. If your call goes unanswered for a preset time period and a 15-second high-pitched tone sounds followed by silence, press the **Goodbye** key or replace the handset.

### To use Automatic Post-selection:

The called party is either busy on the IP Phone or away from their desk. To page the called party, you do not need to redial the number of the called party.

RadPag



1. Press the **Radio Page** soft key. A special dial tone sounds.



2. Dial the **Radio Paging Access** FFC. The ringback tone sounds.

The paged person can use any IP Phone to enter a **Radio Paging Answer** FFC, plus their own DN number.



(Goodbye)

or



3. If your call goes unanswered for a preset time period and a 15-second high-pitched tone sounds, followed by silence, press the **Goodbye** key or replace the handset.

### To answer a Radio Page:

If you carry a Radio Pager, a page indicates that someone dialed your DN. If the Radio Page system is configured to function in Meet-me mode, you can answer the page call from any IP Phone.



1. Lift the handset.



2. Dial the **Radio Page Answer** FFC. The paging tone sounds.



3. Dial your own DN to connect to the paging caller. If the caller has disconnected, a steady high-pitched (number unavailable) tone sounds.

## Using Voice Call

Use the Voice Call feature to make an announcement through someone else's IP Phone speaker.

### To make a voice call:



1. Lift the handset.

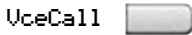

2. Press the **Voice Call** key and make the announcement.



(Goodbye)

3. Press the **Goodbye** key.

### To respond to a voice call:



Your IP Phone rings once and the caller's voice transmits through your speaker. Lift the handset.

# Additional phone features

The following features are described in this section:

- “Using the Personal Directory” on page 133
- “Using the Callers List” on page 136
- “Using the Redial List” on page 138
- “Using Virtual Office” on page 140
- “Using Media Gateway 1000B” on page 149

## Using the Personal Directory

Use the Personal Directory feature to create and store up to 100 directory entries. A Personal Directory entry can contain:

- last name (up to 24 characters)
- first name (up to 24 characters)
- phone numbers (up to 31 characters)

To use the Personal Directory, press the **Directory** key and select **Personal Directory**.

**To add an entry:**



1. Press the **Add** soft key.

If the message *Directory is full* appears, delete one or more entries to add a new entry.



2. Use the dialpad to enter the name.

Next



3. Press the **Next** soft key.



4. Use the dialpad to enter the phone number.

Done



or

Cancel



5. Do one of the following:
  - Press the **Done** soft key to save the new entry.
  - Press the **Cancel** soft key to return to the Add screen.

### To edit an entry:



1. Press the **Up/Down** navigation keys to scroll and highlight the desired entry.

Edit



2. Press the **Edit** soft key and perform your edits.

Done



or

Cancel



3. Choose one of the following:
  - Press the **Done** soft key to save the changes.
  - Press the **Cancel** soft key to return to the Personal Directory without saving your changes.

**To delete an entry:**

Delete



Confirm



or

Cancel



1. Press the **Up/Down** navigation keys to scroll and highlight the desired entry.
2. Press the **Delete** soft key.
3. Choose one of the following:
  - Press the **Confirm** soft key to delete the entry.
  - Press the **Cancel** soft key to return to the Personal Directory without deleting the entry.

**To search for an entry:**

Dial



or

Cancel



1. Press the **Up/Down** navigation keys to scroll and highlight the desired entry.
2. Choose one of the following:
  - Press the **Dial** soft key to dial the resulting number.
  - Press the **Cancel** soft key to exit without dialing.

## Using the Callers List

---

The Callers List feature logs all incoming calls. The Callers List can store up to 100 entries. When the list is full, the system overwrites the oldest entry. Use the Callers List feature to review missed calls and to dial calls. The Callers List contains:

- the caller's last and first name (if available)
- the DN of the caller
- the time and date of the call
- the number of times the caller called

Entries in the Callers List are sorted by the time the call arrived.

The appearance of names in the Callers List depends on the configuration of Preferred Name Match. If Preferred Name Match is activated on your phone, the Calling Party Name Display (CPND) appears according to the configuration settings on your phone. If Preferred Name Match is off, the CPND appears according to the system configuration.

To access the Callers List, press the **Directory** key and select **Callers List**. If password control is enabled, you must enter your SCPW at the prompt.



**To dial an entry:**

Dial



1. Press the **Up/Down** navigation keys to scroll and highlight the desired entry.
2. Press the **Dial** soft key.

**To delete an entry:**

Delete



1. Press the **Up/Down** navigation keys to scroll and highlight the desired entry.
2. Press the **Delete** soft key.

Confirm



or

Cancel



3. Choose one of the following:
  - Press the **Confirm** soft key to delete the entry.
  - Press the **Cancel** soft key to return to the Personal Directory without deleting the entry.

### To delete the entire Callers List:

Delete



1. Press the **Delete** soft key.

2. Choose one of the following soft keys:

Yes



or

No



— **Yes** to delete the entire Callers List

— **No** to return to the previous screen

## Using the Redial List

---

The Redial List feature logs all outgoing calls. Redial List can store up to 20 entries. When the list is full, the system overwrites the oldest entry. Use the Redial List feature to review calls made, and to redial previously dialed calls. The Redial List contains:

- the last and first names of the dialed party (if available)
- the DN of the dialed party
- the time and date of the last dialed occurrence

Entries in the Redial List are sorted by the time the call was received.

The appearance of names in the Redial List depends on the configuration of Preferred Name Match. If Preferred Name Match is activated on your phone, the Calling Party Name Display (CPND) appears according to the configuration settings on your phone. If Preferred Name Match is off, the CPND appears according to the system configuration.

To access Redial List, press the **Directory** key and select **Redial List**. If password control is enabled, you must enter your SCPW at the prompt.

**To dial an entry:**



Dial



1. Press the **Up/Down** navigation keys to scroll and highlight the desired entry.
2. Press the **Dial** soft key.

**To delete an entry:**



Delete



1. Press the **Up/Down** navigation keys to scroll and highlight the desired entry.
2. Press the **Delete** soft key.

Yes

No

or



3. Choose one of the following soft keys:
  - **Yes** to delete the entry
  - **No** to return to the previous screen

**To delete the entire Redial List:**

Delete



1. Press the **Delete** soft key.

Yes

No

or



2. Choose one of the following soft keys:
  - **Yes** to delete the entire Redial List
  - **No** to return to the previous screen

## Using Virtual Office

The Virtual Office feature provides a service you can use while you are away from your desk to transfer calls, and all your office IP Phone features, to a remote IP Phone. Virtual Office makes this possible by allowing you to use another IP Phone (the Remote phone) to log in to your own home or office IP Phone (the Office phone). After you log in, you can access the DNs, autodial numbers, key layout, feature keys, and voicemail features that are configured on your own home or office IP Phone.

To use Virtual Office, you need your DN and preconfigured Station Control Password (SCPW). You must activate Virtual Office on your Office phone before you can connect to it from a Remote phone. See “Logging in to Virtual Office” on page 141.

Consult your system administrator to verify if the Virtual Office feature is available for your use.

You can use an IP Phone as a Remote phone to connect to your IP Phone 1140E even if it is a different IP Phone model. Table 8 shows the IP Phones on which you can use Virtual Office to connect to your IP Phone 1140E.

**Table 8: Virtual Office connection availability**

Using IP Phone	Possible to log in to the 1140E?
IP Phone 1120E	Yes, with restrictions
IP Phone 1140E	Yes
IP Phone 1150E	No
IP Phone 1110	Yes, with restrictions
IP Phone 2001	Yes, with restrictions
IP Audio Conference Phone 2033	Yes, with restrictions
IP Phone 2002	Yes

**Table 8: Virtual Office connection availability**

Using IP Phone	Possible to log in to the 1140E?
IP Phone 2004	Yes
IP SoftPhone 2050	Yes, with restrictions
IP Phone 2007	Yes

**Note:** A Virtual Office login from an IP Phone 1140E to an IP Phone 1120E or IP Softphone 2050 is blocked in certain situations. Consult your system administrator.

## Logging in to Virtual Office

To activate Virtual Office on your Office IP Phone from your Remote IP Phone:



(Services)

1. Press the **Services** key.



2. Press the **Up/Down** navigation keys to scroll and highlight **Virtual Office Login**.



3. Press the **Enter** key.



4. At the prompt, enter your user ID.



5. Press the **Enter** key.



6. At the prompt, enter the home **Station Control Password (SCPW)**.

If the user ID is not found locally, the message *Locating Remote Server* appears.

After three failed login attempts, wait 1 hour before attempting to log in again, or contact your system administrator to reset your password. For more information, see “Security features” on page 21.

A successful login transfers all the features, time, date, and tones to your Remote IP Phone from your Office IP Phone. Your Virtual Office session expires after a fixed period of time, (determined by your system administrator).

### Using Virtual Office on your Remote IP Phone

Because the display characteristics, including size, vary from one IP Phone model to the next, your Office IP Phone 1140E display is different on each Remote phone. Figure 9 shows an IP Phone 1140E logged in as a Remote phone to an IP Phone 1140E Office phone. All the features appear as they do on your Office IP Phone 1140E.

**Figure 9: Logged in to an IP Phone 1140E**

Figure 10 shows an IP Phone 1120E logged in as a Remote phone to an IP Phone 1140E Office phone. Fewer display lines are available on the 1120E, so the display provides less information.

**Figure 10: Logged in to an IP Phone 1140E using an IP Phone 1120E**

Figure 11 shows an IP Softphone 2050 logged in as a Remote phone to an IP Phone 1140E Office phone. In this case, the information display is arranged in a different fashion, but all the information is visible at one time.

**Figure 11: Logged in to an IP Phone 1140E using an IP Softphone 2050**

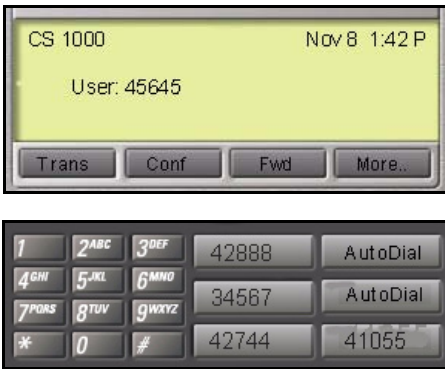

Regardless of what model of IP Phone you use as a Remote phone, a User information line appears, which lists the number of your Office IP Phone.

## Using Virtual Office on your Office IP Phone

Figure 12 shows the IP Phone 1140E display when the phone is logged out due to remote access.



**Figure 12: Office phone displays the message *Logged Out***

When activated for Virtual Office by a Remote IP Phone, your Office IP Phone is *logged out* and no longer operational. If this is the case when you return to your office, you can disconnect the remote login and regain control of your Office phone. If you do not disconnect the remote login, your Virtual Office session expires after a fixed period of time, determined by your system administrator.

### To regain operation of a IP Phone being used for Virtual Office:

Choose one of the following:

Home 



or

Virtual



— To completely disconnect your Office IP Phone from the Remote IP Phone:

- a. Press the **Home** key.
- b. Enter your User ID and password (this logs the Office IP Phone back on to your office network).

— Press the **Virtual** soft key to log in to another IP Phone, and your IP Phone becomes a Remote IP Phone.

## Logging out of Virtual Office

While working on a Remote phone, you can log out of Virtual Office using the following steps.

### To log out from a Remote IP Phone:



(Services)

1. Press the **Services** key.



2. Press the **Up/Down** navigation keys to scroll and highlight **Virtual Office Logout**.



3. Press the **Enter** key.

## Troubleshooting Virtual Office

Virtual Office can cause error messages to display on-screen. Table 9 lists error messages and describes actions to correct the causes.

**Table 9: Troubleshooting Virtual Office (Part 1 of 3)**

Displayed Message	Probable Cause	Actions
Busy, try again	Remote IP Phone is active (not idle).	Wait for remote IP Phone to become idle and try again.
	ACD is logged in.	Log out of ACD IP Phone before initiating Virtual Office from another IP Phone.
	Make Set Busy is inactive on ACD IP Phone.	Configure Make Set Busy active on ACD IP Phone.
Invalid ID (1)	Incorrect User ID entered.	Enter correct User ID.
	User ID is not in Gatekeeper database.	Notify system administrator.
Invalid ID (2)	Incorrect User ID entered.	Enter correct User ID.
Invalid ID (3)	Incorrect User ID entered.	Enter correct User ID.
	User ID in Gatekeeper database points to originating Call Server.	Notify system administrator.
Locked from Login	Three failed attempts to enter the correct Station Control Password.	Wait one hour for the lock to clear automatically, or notify system administrator to clear lock.

**Table 9: Troubleshooting Virtual Office (Part 2 of 3)**

Displayed Message	Probable Cause	Actions
Permission Denied (1)	Remote IP Phone has no Station Control Password.	Notify system administrator.
Permission Denied (3)	Incorrect User ID entered.	Enter correct User ID.
	Remote IP Phone has no Station Control Password.	Notify system administrator.
Permission Denied (4)	Incorrect User ID entered.	Enter correct User ID.
	Attempt to log in to a remote IP Phone 1120E or IP Softphone 2050 from an IP Phone 1140E (some restrictions apply).	Go to an IP Phone 1120E or IP Softphone 2050 and try again, or consult your local system administrator.
Permission Denied (5)	Incorrect User ID entered.	Enter correct User ID.
	Remote IP Phone does not have VOUA Class of Service.	Notify system administrator.
Permission Denied (6)	Incorrect User ID entered.	Enter correct User ID.
	Incorrect Station Control Password entered.	Select Retry, and try again with the correct Station Control Password.

**Table 9: Troubleshooting Virtual Office (Part 3 of 3)**

Displayed Message	Probable Cause	Actions
Server Unreachable (1)	Network problem.	Notify system administrator if the problem persists.
Server Unreachable (2)	Network problem.	Notify system administrator if the problem persists.

## Using Media Gateway 1000B

The Media Gateway 1000B (MG 1000B) provides a means of extending CS 1000 Release 4.5 features to one or more remotely located branch offices using the Branch Office feature. A branch office is a remote location in the network where IP Phones, PSTN access, and TDM IP Phones are located. Contact your system administrator to see if these functions are available for your use.

The Media Gateway 1000B (MG 1000B) IP Phone can operate in Normal or Local Mode.

### Normal Mode

The IP Phone registers with the Main Office and receives IP Phone services from the Main Office. At any time while using Normal Mode, you can check Local Mode functionality (make and receive calls) by enabling Local Mode and returning to Normal Mode. After testing, you can return to Normal Mode (see “Using Resume Normal Mode” on page 150) or wait for 10 minutes.

### Local Mode

If the WAN connection goes down, the IP Phone loses communication with the Main Office TPS. It then registers with the MG 1000B and receives IP Phone services from the MG 1000B. Features such as Personal Directory, Redial List, and Callers List are not available when operating in Local Mode. When in Local Mode, the IP Phone displays the message *LOCAL MODE*.

### Using Test Local Mode

Use Test Local Mode to check Local Mode functionality (make and receive IP Phone calls). Test Local Mode is useful when provisioning has changed for an IP Phone on an MG 1000B Controller.



(Services)

1. Press the **Services** key.



2. Press the **Up/Down** navigation keys to scroll and highlight Test Local Mode.



3. Press the **Enter** key (the IP Phone resets and registers back to the branch office).

### Using Resume Normal Mode

Use the Resume Normal Mode command to return to Normal Mode after testing survival functionality. If you do not use the Resume Normal Mode command after testing, the IP Phone automatically returns to Normal Mode in 10 minutes.



(Services)

1. Press the **Services** key.



2. Press the **Up/Down** navigation keys to scroll and highlight **Resume Normal Mode**.



3. Press the **Enter** key (the IP Phone registers back to the main office).

## Troubleshooting MG 1000B

The MG 1000B can cause error messages to display on-screen. Table 10 lists error messages and describes actions to correct the causes.

**Table 10: Troubleshooting MG 1000B**

Display Message	Probable Cause	Actions
Local Mode	Test Local Mode.	Press the <b>Services</b> key, and then select Resume Normal Mode.
	Network problem.	Contact system administrator if problem persists.
Local Mode Invalid ID (1)	Gatekeeper unable to find end point from Branch User ID.	Notify system administrator.
Local Mode Invalid ID (2)	Branch User ID not found in any equipped Terminal Number (TN).	Notify system administrator.

# Using Hospitality features

Hospitality features are intended for hotel operations.

## Configuring Automatic Wake-Up

---

Use the Automatic Wake-Up feature to receive a timed reminder call. From your IP Phone, you can program the system to automatically place a call to you at a predetermined time. When you answer the call, recorded music plays for up to 30 seconds, followed by a prerecorded announcement or the attendant.

**To enter the time for an Automatic Wake-Up call:**



1. Lift the handset.



2. Dial the **Automatic Wake-Up Request FFC**.



3. Dial the **Automatic Wake-Up** time in a 24-hour time format (hhmm). A tone sounds to confirm your entered time.

To enter the time in a 24-hour time format, enter the hours followed by the minutes. For example, to set the time to 7:30 a.m., enter 0730; to set it to 9:45 p.m., enter 2145.



(Goodbye)

4. Press the **Goodbye** key.



### To cancel an Automatic Wake-Up call:



1. Lift the handset.



2. Dial the **Automatic Wake-Up Quit** FFC.



(Goodbye)

3. Press the **Goodbye** key.

### To verify the time for the Automatic Wake-Up call:



1. Lift the handset.



2. Dial the **Automatic Wake-Up Verify** FFC.



3. Dial the **Automatic Wake-Up** time in a 24-hour time format (hhmm). If your query matches the preset time, a confirmation tone sounds.

To enter the time in a 24-hour time format, enter the hours followed by the minutes. For example, to set the time to 7:30 a.m., enter 0730; to set it to 9:45 p.m., enter 2145.



(Goodbye)

4. Press the **Goodbye** key.

## Activating Message Registration

---

Use the Message Registration feature to read, change, or reset meters that log your hotel phone calls.

### To read meters:



1. Press the **Message Registration** key.



2. Dial the room **Directory Number** (DN).



3. Press the **Message Registration** key.

### To change a meter:



1. Press the **Message Registration** key.



2. Dial the room **Directory Number** (DN).



3. Dial the correct meter count.



4. Press the \* key.



5. Press the **Message Registration** key.

**To reset a meter to zero:**

1. Press the **Message Registration** key.



2. Dial the room **Directory Number (DN)**.



3. Press the **\*** key.



4. Press the **Message Registration** key.

## Using Maid Identification

---

Use the Maid Identification feature to track the cleaning status of rooms. The maid enters the information from the IP Phone in each room.

**To enter cleaning status:**

1. Press the **Room Status** key.



2. Dial the **Directory Number (DN)** for the room.



3. Dial one of the following cleaning status codes:

1 = Cleaning requested

2 = Cleaning in progress

3 = Room cleaned

4 = Room passed inspection

5 = Room failed inspection

6 = Cleaning skipped

The interrupted dial tone sounds.



4. Press the \* key.



5. Dial the **Maid** ID. If you dial the wrong **Maid** ID, press the \* key and redial the ID.

RMK



6. Press the **Room Status** key.

## Displaying Room Status

---

Use the Room Status feature to display the status of a room using the Display Module.

**To display the status of a room:**

RMK



1. Press the **Room Status** key.



2. Dial the **Directory Number** (DN) for the room. The DN appears followed by a two-digit code.

The first digit indicates the occupancy status:

0 = Room vacant

1 = Room occupied

The second digit indicates the cleaning status of the room:

1 = Cleaning requested

2 = Cleaning in progress

3 = Room cleaned

4 = Room passed inspection

5 = Room failed inspection

6 = Cleaning skipped

RMK



3. Press the **Room Status** key.

### Changing the status of a room:

RMK



1. Press the **Room Status** key.



2. Dial the **Directory Number** (DN) for the room. The DN appears followed by a two-digit code.

The first digit indicates the occupancy status:

0 = Room vacant

1 = Room occupied

The second digit indicates the cleaning status of the room:

1 = Cleaning requested

2 = Cleaning in progress

3 = Room cleaned

4 = Room passed inspection

5 = Room failed inspection

6 = Cleaning skipped



3. Dial the status code for the room. A three-digit code appears. The first digit indicates the occupancy status, the second is the previous cleaning status, and the third is the new status.

RMK



4. Press the **Room Status** key.

# Accessing External Server Applications

Use External Server Applications to access a variety of applications directly from your IP Phone 1140E.

To find out what features and services are available, contact your system administrator. Depending on what is available on your system, your phone can provide information; for example, local news and weather, stock market information, or traffic reports.

For more information about the External Server Applications, consult the *Nortel IP Phone External Server Applications User Guide*.

# Flexible Feature Codes (FFCs)

Use Table 11 to track the FFCs assigned by your system administrator.

**Table 11: Flexible Feature Codes**

FFC	Feature	FFC	Feature
	Automatic Wake-Up Activate		Make Set Busy Activate
	Automatic Wake-Up Deactivate		Make Set Busy Deactivate
	Automatic Wake-Up Verify		Malicious Call Trace
	Call Detail Recording Charge Account		Override
	Call Forward All Calls Activate		Pickup Ringing Number
	Call Forward All Calls Deactivate		Pickup Directory Number
	Call Park		Pickup Group
	Electronic Lock Activate		Radio Paging Access
	Electronic Lock Deactivate		Radio Paging Answer
	Group Call		Remote Call Forward Activate
	Internal Call Forward Activate		Remote Call Forward Deactivate
	Internal Call Forward Deactivate		RingAgain Activate
	RingAgain Deactivate		Virtual Office Terminal Log Off
	Station Control Password Change		Virtual Office Terminal Log On



# Regulatory and safety information

This equipment has been tested and found to comply with the limits for a Class B digital device, pursuant to part 15 of the FCC Rules. These limits are designed to provide reasonable protection against harmful interference in a residential installation. This equipment generates, uses and can radiate radio frequency energy and, if not installed and used in accordance with the instructions, may cause harmful interference to radio communications. However, there is no guarantee that interference will not occur in a particular installation. If this equipment does cause harmful interference to radio or television reception, which can be determined by turning the equipment off and on, the user is encouraged to try to correct the interference by one or more of the following measures:

- Reorient or relocate the receiving antenna.
- Increase the separation between the equipment and receiver.
- Connect the equipment into an outlet on a circuit different from that to which the receiver is connected.
- Consult the dealer or an experienced radio/ TV technician for help.

**Note:** The user should not make changes or modifications not expressly approved by Nortel Networks. Any such changes could void the user's authority to operate the equipment

This Class B digital apparatus complies with Canadian ICES-003. Cet appareil numérique de la classe B est conforme à la norme NMB-003 du Canada.

## Warnings:

- This is a Class B product. In a domestic environment this product can cause radio interference in which case the user must take adequate measures.
- Operation is subject to the following two conditions: (1) this device may not cause interference, and (2) this device must accept any interference, including interference that may cause undesired operation of the device."
- Privacy of communications may not be ensured when using this IP Phone.

- This equipment complies with FCC radiation exposure limits set forth for an uncontrolled environment. This equipment should be installed and operated with a minimum distance of 20cm between the radiator and your body (excluding the handset). This transmitter must not be colocated or operated in conjunction with any other antenna or transmitter.

To prevent radio interference to the licensed service, this device must be operated indoors only and should be kept away from windows to provide maximum shielding.

この装置は、情報処理装置等電波障害自主規制協議会（VCCI）の基準に基づくクラスB情報技術装置です。この装置は、家庭環境で使用することを目的としていますが、この装置がラジオやテレビジョン受信機に近接して使用されると、受信障害を引き起こすことがあります。

取扱説明書に従って正しい取り扱いをして下さい。

Table 12 lists EMC compliance for various jurisdictions.

**Table 12: EMC compliance (Part 1 of 2)**

Jurisdiction	Standard	Description
United States	FCC CFR 47 Part 15	Class B Emissions: FCC Rules for Radio Frequency Devices (see Notes 1 and 2)
Canada	ICES-003	Class B Emissions: Interference-Causing Equipment Standard: Digital Apparatus
Australia/ New Zealand	AS/NZS 3548 CISPR 22	Class B Emissions: Information technology equipment - Radio disturbance

**Table 12: EMC compliance (Part 2 of 2)**

Jurisdiction	Standard	Description
European Community	EN 55022	Class B Emissions: Information technology equipment - Radio disturbance
	EN 55024	Information technology equipment - Immunity characteristics Limits and methods of measurement
	EN 61000-3-2	Limits for harmonic current emissions (equipment input current $\leq$ 16 A per phase)
	EN 61000-3-3	Limitation of voltage fluctuations and flicker in low-voltage supply systems for equipment with rated current $\leq$ 16 A
Japan	VCCI	Regulations for voluntary control measures.

Table 13 lists Safety compliance for various jurisdictions.

**Table 13: Safety compliance**

Jurisdiction	Standard	Description
United States	UL 60950-1	Safety of Information Technology Equipment
Canada	CSA 60950-1-03	Safety of Information Technology Equipment
European Community	EN 60950-1	ITE equipment - Safety - Part 1: General requirements
Australia/New Zealand	AS/NZS 60950.1:2003	Safety of Information Technology Equipment

Other Safety Approvals: IEC 60950-1: ITE equipment - Safety - Part 1: General requirements.

## Other

**US/Canada:** Hearing Aid Compatibility (HAC) as per FCC Part 68

This equipment complies with the CE Marking requirements. 

**EU Countries:** This device complies with the essential requirements and other relevant provisions of Directive 1999/5/EC. A copy of the Declaration may be obtained from [www.nortel.com](http://www.nortel.com) or Nortel Networks GmbH address: Ingolstaedter Strasse 14-18, 80807 Munich Germany

**Australia: AS/ACIF S004:** Voice Frequency Performance Requirements for Customer Equipment

**Bluetooth wireless technology:** This portable device with its antenna complies with FCCs RF radiation exposure limits for an uncontrolled environment. To maintain compliance, this transmitter must not be collocated or operate in conjunction with any other antenna or transmitter.

## DenAn regulatory notice for Japan

### Warning

Please be careful of the following while installing the equipment:

- Please only use the Connecting cables, power cord, AC adaptors shipped with the equipment or specified by Nortel to be used with the equipment. If you use any other equipment, it may cause “failures, malfunctioning or fire”.
- Power cords shipped with this equipment must not be used with any other equipment. In case the above guidelines are not followed, it may lead to death or severe injury

### 警告

本製品を安全にご使用頂くため、以下のことにご注意ください。

- 接続ケーブル、電源コード、ACアダプタなどの部品は、必ず製品に同梱されております。添付品または指定品をご使用ください。添付品・指定品以外の部品をご使用になると故障や動作不良、火災の原因となることがあります。
- 同梱されております付属の電源コードを他の機器には使用しないでください。上記注意事項を守らないと、死亡や大怪我など人身事故の原因となることがあります。

# Terms you should know

## Calling Party Name Display

Information appearing on the LCD display screen, such as the caller's name and phone number. The system must have CPND enabled.

## Category 5 (Cat5)

Cable and associated connecting hardware capable of transmitting at speeds up to 100 MHz, used by 10BaseT, 100BaseT4, 100BaseTX.

## Category 5e (Cat5e)

Most Cat5 cable manufactured after 1996 also supports 1000BaseT (GigE) installations, and is designated Cat 5e. Cat5e cable normally has four pairs of copper wire.

## Category 6 (Cat6)

Cable and associated connecting hardware capable of transmitting at speeds up to 200 MHz. Designed specifically to support 1000BaseT (GigE), it is also compatible with 10BaseT, 100BaseT4, and 100BaseTX installations. The cable normally has four pairs of copper wire.

## Communication Server 1000

Your office communication system.

## Context-sensitive soft keys

A set of keys programmed by your system administrator. These four keys, located directly below the display area, have four programmable layers. These keys are also used to configure parameters in the [Telephone Options](#) menu.

## Date/time display

The current date and time when the IP Phone is in an idle state.

### Directory Number (DN)

A number consisting of one to seven digits for an IP Phone, and also known as an *extension number*.

### Feature display

An area that shows status information about the feature in use. It also displays the name and status of the active session.

### Feature Status Lamp indicator

An LCD or an LED that indicates a data message, contact, or feature status by a flash, wink, steady on, or off.

### Fixed key

The hard-labeled keys on your IP Phone.

### Flexible Feature Codes (FFCs)

Specialized codes entered using the dialpad that enable features (for example, Ring Again).

### Goodbye key

A fixed key used to end an active call.

### Indicator

An LCD or an LED that indicates the status of a feature by the flash, wink, steady on, or off.

### Information display

Any display of call activity, lists, prompts, and status of calls. If the text message exceeds the available display area, a scroll arrow icon indicates that you must use the scroll keys to view the remaining text.

### Interrupted dial tone

A broken or pulsed dial tone that sounds when you access some features on your IP Phone.

### **Message/Inbox**

A fixed key on your IP Phone 1140E that connects to your voice messaging system when the key is pressed.

### **Navigation keys**

Keys used to scroll through menus and lists appearing on the LCD display screen.

### **Off-hook**

Any line selected to make a call or receive an incoming call. The term *off-hook* is applied whether (a) the end user lifts up the handset, (b) the end user presses a line key, (c) the call is automatically answered at the IP Phone, or (d) a line is automatically selected for an outgoing call.

### **Paging tone**

A special tone (two beeps followed by dial tone) that sounds when you use the Radio Paging feature.

### **Ringback/ring tone**

A sound indicating that a call you have made is ringing at its destination.

### **Services key**

A fixed key used to access options such as Telephone Options, Password Admin, Virtual Office Login, Virtual Office Logout, Test Local Mode, and Resume Normal Mode.

### **Shared Directory Number**

A DN (extension) that is shared by two or more persons.

### **Special Prefix code (SPRE)**

Special codes entered using the dialpad, followed by a two-digit access code, that enable features (for example, Call Forward All Calls requires entry of SPRE code + 74).

### **Special dial tone**

The three consecutive tones followed by dial tone that you hear when accessing IP Phone features.

### **Station Control Password (SCPW)**

Enables security features on your phone to prevent others from making calls from your IP Phone and to prevent access to protected features (for example, Remote Call Forward).

### **Status Messages**

A message displayed to inform the user of important information. A right arrow appears if more than one Status Message is present. Examples of Status Messages include: Message Waiting, All Lines Forwarded to: 6453, Do Not Disturb On, Ring Again active, and Ringer is OFF.

### **System or Switch**

Your office communication system.

### **Switchhook**

A button on which the handset presses down, disconnecting your call when you replace the handset. The handset (when lifted) releases the switchhook, and you either answer an incoming call or you receive a dial tone to make a call.

### **User interface**

Screen displays that interact with the end user as a result of an action or event.

### **Visual Alerter/Message Waiting indicator**

An LCD or an LED that flashes to indicate that a message is waiting or when the ringer is on.



# Index

## A

About the IP Phone 2004 11, 165  
 Answer a call 94  
 Attendant Recall 98  
 AutoDial 87  
 AutoDial Transfer 120  
 Automatic Answerback 103  
 Automatic Wake-Up 152

## B

Buzz signal 121

## C

Call Features and Flexible Feature Codes 20  
 Call Forward 107  
 Call Join 113  
 Call Page Connect 121  
 Call Park 98  
 Call party information 165  
 Call Pickup 103  
 Call timer 49  
 Call Waiting 105  
 Callers List 85  
 Calling Party Number 101  
 Camp-on, Forced 127  
 Centrex/Exchange Line Switch-hook Flash 122  
 Change feature key labels 49  
 Charge a call or charge a forced call 123  
 Conferee Selectable Display and

Disconnect 115  
 Conference call 113  
 Configure area code setup 45  
 Configure call log options 54  
 Configure Callers List log 43  
 Configure Name Display format 47  
 Configure New Call indication 44  
 Configure Preferred Name Match 45  
 Connect the components 27  
 Context-sensitive soft keys 14, 165  
 Contrast adjustment 37  
 Copy key 17  
 Corporate Directory 83

## D

Date/time display 165  
 Date/Time format 39  
 Directory applications 83  
 Directory key 18  
 Directory Number 166  
 disconnect a conferee 116  
 Display incoming calls 101  
 Display Network Diagnostics Utilities 19  
 DN 166

## E

Electronic Lock 111  
 Encrypted calling 21  
 Enhanced Override 126

Enter key 16  
Entering and editing text 24  
Expand key 16  
External server applications 159

**F**

Feature display 166  
Fixed key 166  
Flexible Feature Code (FFC) 166  
Flexible Feature Codes (FFCs)  
160

**G**

Goodbye key 16, 166  
Group Call 116

**H**

Handsfree dialing 81  
Headset key 16  
Hold key 16  
Hospitality features 152

**I**

Indicator status 166  
Information display 166  
Intercom call 92  
Internal Call Forward 108  
Interrupted dial tone 166

**L**

Language display 38  
Last Number Redial 90  
Line (DN) key 14  
Local Area Network (LAN) 11

Local Diagnostics 77  
Local Dialpad Tone 40  
Local Mode 149

**M**

Maid Identification 155  
Make Set Busy 119  
Malicious Call Trace 102  
Media Gateway 1000B 149  
Meet - me page 130  
Message (Inbox) key 17  
Message key 167  
Message Registration 154  
Message waiting indicator 17, 168  
More key 14  
Mute key 15

**N**

Navigation keys 15, 167  
Normal Mode 149

**O**

Off-hook 167  
Off-hook dialing 79  
Onhook Default Path 49  
On-hook dialing 80  
Override a busy signal 128

**P**

Paging tone 167  
Personal Directory 84  
Place a call on hold 95  
Predial feature 86  
Privacy Release 129

**Q**

Quit/Stop key 17

**R**

Radio Page 129

Record a Calling Party Number  
101

Redial List 84, 86

Regulatory and safety information  
161

Remote Call Forward 109

Resume Normal Mode 150

Ring Again 89

Ring type 49

Ringback/ring tone 167

Room Status 156

**S**

Secure your telephone 111

Security features 21

Self-labeled line/programmable  
feature keys 14

Services key 18, 167

Shared Directory Numbers 167

Shift/Outbox key 17

Speaker key 15

Special dial tone 168

Special Prefix code (SPRE) 167

Speed Call 90

Station Control Password (SCPW)  
21, 168

Status Messages 168

Switchhook 168

System or Switch 168

**T**

Telephone display 20

Telephone information 54

Telephone Options 35

Test Local Mode 150

Timed Reminder Recall 97

Transfer a call 96

**U**

USB keyboard

function keys 25

User Interface 168

**V**

Virtual Office 140

Virtual Office login 141

Virtual Office logoff 146

Virtual Office on your Remote tele-  
phone 142

Voice Call 131

Volume adjustment 36

Volume control bar 15





Nortel Communication Server 1000

# IP Phone 1140E

## User Guide

Copyright © 2009, Nortel Networks. All Rights Reserved

### LEGAL NOTICE

While the information in this document is believed to be accurate and reliable, except as otherwise expressly agreed to in writing, NORTEL PROVIDES THIS DOCUMENT “AS IS” WITHOUT WARRANTY OR CONDITION OF ANY KIND EITHER EXPRESS OR IMPLIED. The information and/or products described in this document are subject to change without notice.

Nortel, the Nortel logo, the Globemark, SL-1, Meridian 1, and Succession are trademarks of Nortel Networks.

The *Bluetooth* word mark and logos are owned by the Bluetooth SIG, Inc. and any use of such marks by Nortel Networks is under license.

All other trademarks are the property of their respective owners.

Publication Number: NN43113-106

Document Release: Standard 02.06

Date: March 2009

Sourced in Canada

To provide feedback or report a problem in this document, go to [www.nortel.com/documentfeedback](http://www.nortel.com/documentfeedback).



[www.nortel.com](http://www.nortel.com)